



Carl Zeiss Microscopy GmbH
07745 Jena, Germany

microscopy@zeiss.com
www.zeiss.com/microscopy



We make it visible.

EN_40_010_001 | CZ 10-2013 | Design, scope of delivery, and technical progress subject to change without notice. | © Carl Zeiss Microscopy GmbH

ZEISS

The Profile: The Modular System of Stereo- and Zoom Microscopes



The Profile The Modular System of Stereo- and Zoom Microscopes

SteREO Discovery.V8 | SteREO Discovery.V12 | SteREO Discovery.V20
Axio Zoom.V16



We make it visible.



The Profile The Modular System of Stereo- and Zoom Microscopes

SteREO Discovery.V8 | SteREO Discovery.V12 | SteREO Discovery.V20
Axio Zoom.V16

SteREO Discovery

Microscope Bodies 6
 Observation Tubes 7
 Co-observation Configurations .. 8
 Intermediate Tubes 9
 Exchangeable Optics 10
 Axial Mode 12
 Fluorescence Illumination 14
 Polarization Contrast 16
 Coaxial Illumination 17
 Technical Specifications 18

Axio Zoom.V16

Microscope Bodies 22
 Observation Tubes 23
 Exchangeable Optics 24
 Fluorescence Illumination 26
 Coaxial Illumination 28
 Technical Specifications 30

Accessories

Stands 34
 Stages 36
 Illumination 38
 Operating Devices 44
 Image Documentation 54
 Image Processing 56
 Technology 60
 Service and Support 62



SteREO Discovery

The human ability to perceive our surroundings in 3D is one of evolution's most impressive masterstrokes. Even when seen at a microscopic level, our world has three rich dimensions. In 1897, Carl Zeiss opened a window on it by giving scientists a groundbreaking instrument: the Greenough stereo microscope. Since then, stereo microscopes have been improved and enhanced to meet new challenges and become an essential tool for scientists and engineers.

Now, SteREO Discovery.V8, SteREO Discovery.V12, and SteREO Discovery.V20 have set new quality standards in optical clarity, stability, and ease of use. Their patented ZEISS lenses with electronic zoom curves provide you with significantly sharper three-dimensional images and previously unattained levels of contrast.



Microscope Bodies

Explore the outer reaches of optics with SteREO Discovery stereo microscopes.



Use our **Resolution Test Slide 3000** to test your stereo microscope's actual resolution.

A microscope body's zoom magnification changer is not only the heart of a zoom stereo microscope, but is also key to the entire system's performance.

With a maximum numerical aperture (NA) of 0.144*, SteREO DiscoveryV12 and SteREO DiscoveryV20 rank among the most powerful stereo microscopes in the world.



Combine SteREO DiscoveryV12 with the PlanApo S 2.3x objective to obtain resolutions of up to 1,000 line pairs per millimeter (LP/mm).

You can choose from three microscope bodies:

SteREO Discovery.V8

- Apochromatic zoom optics
- 1x–8x manual zoom
- Maximum NA of 0.116*
- Shiftable click stops

SteREO Discovery.V12

- Apochromatic zoom optics
- 0.8x–10x motorized zoom
- Maximum NA of 0.144*
- Electronic click stops
- Double-iris diaphragm
- Selectable zoom speed
- Information on the system's magnification, resolution, depth of field, and field of view

SteREO Discovery.V20

- Apochromatic zoom optics
- 0.75x–15x motorized zoom
- Maximum NA of 0.144*
- Electronic click stops
- Double-iris diaphragm
- Selectable zoom speed
- Information on the system's magnification, resolution, depth of field, and field of view

* At maximum zoom level with a 1x objective



Observation Tubes

Experience dimensionally accurate images with zero chromatic aberration delivered by our eyepiece tubes, then find the most comfortable viewing angle using our ergotubes.

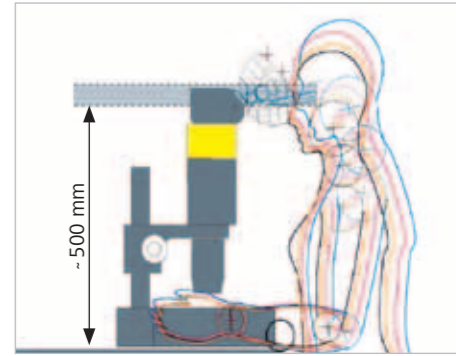

A viewing height of up to 500 mm combined with a viewing angle of 20° – the recommended way to avoid tension and neck pain.

For simple configurations in reflected light, use the **intermediate tube S, 40 mm** to achieve an ergonomic viewing height.



1

Binocular tube S 35°

- Fixed 35° viewing angle
- 55–75 mm adjustable interpupillary distance

3

Binocular phototube S 20°

- Fixed 20° viewing angle
- Tilting eyepiece tubes for two viewing heights
- 55–75 mm adjustable interpupillary distance
- 100/100 photo port; switchable

5

Binocular ergotube S 5-45°

- 5–45° adjustable viewing angle
- Tilting eyepiece tubes for two viewing heights
- 55–75 mm adjustable interpupillary distance

2

Binocular tube S 20°

- Fixed 20° viewing angle
- Tilting eyepiece tubes for two viewing heights
- 55–75 mm adjustable interpupillary distance

4

Binocular ergophototube S 5-45°

- 5–45° adjustable viewing angle
- Tilting eyepiece tubes for two viewing heights
- 55–75 mm adjustable interpupillary distance
- 100/100 photo port; switchable

6

Binocular ergotube S 1.25x 5-45°

- Additional magnification factor of 1.25x
- 5–45° adjustable viewing angle
- Tilting eyepiece tubes for two viewing heights
- 93 mm longer eyepiece tubes
- 55–75 mm adjustable interpupillary distance



Co-observation Configurations



Position and rotate the LED pointer to mark interesting spots on your specimen.

Co-observation configurations enable two people to see an identical stereoscopic specimen image at the same time – with the same level of optical clarity – making these attachments perfect for your discussions, examinations, and teaching scenarios.

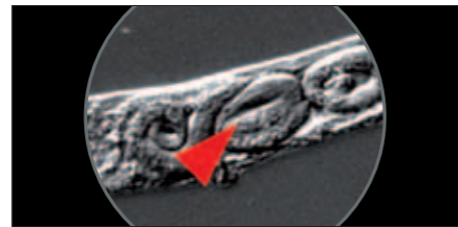

Mark interesting spots on your specimen.



Co-observation equipment for SteREO Discovery.V8, SteREO Discovery.V12, SteREO Discovery.V20

Second head:

- Fixed 20° viewing angle
- Tilting eyepiece tubes for two viewing heights
- 55–75 mm adjustable interpupillary distance
- Distance between the heads' centers: 600 mm

LED pointer:

- Can be moved, rotated, and dimmed as necessary
- Adjustable color (red, green, blue)

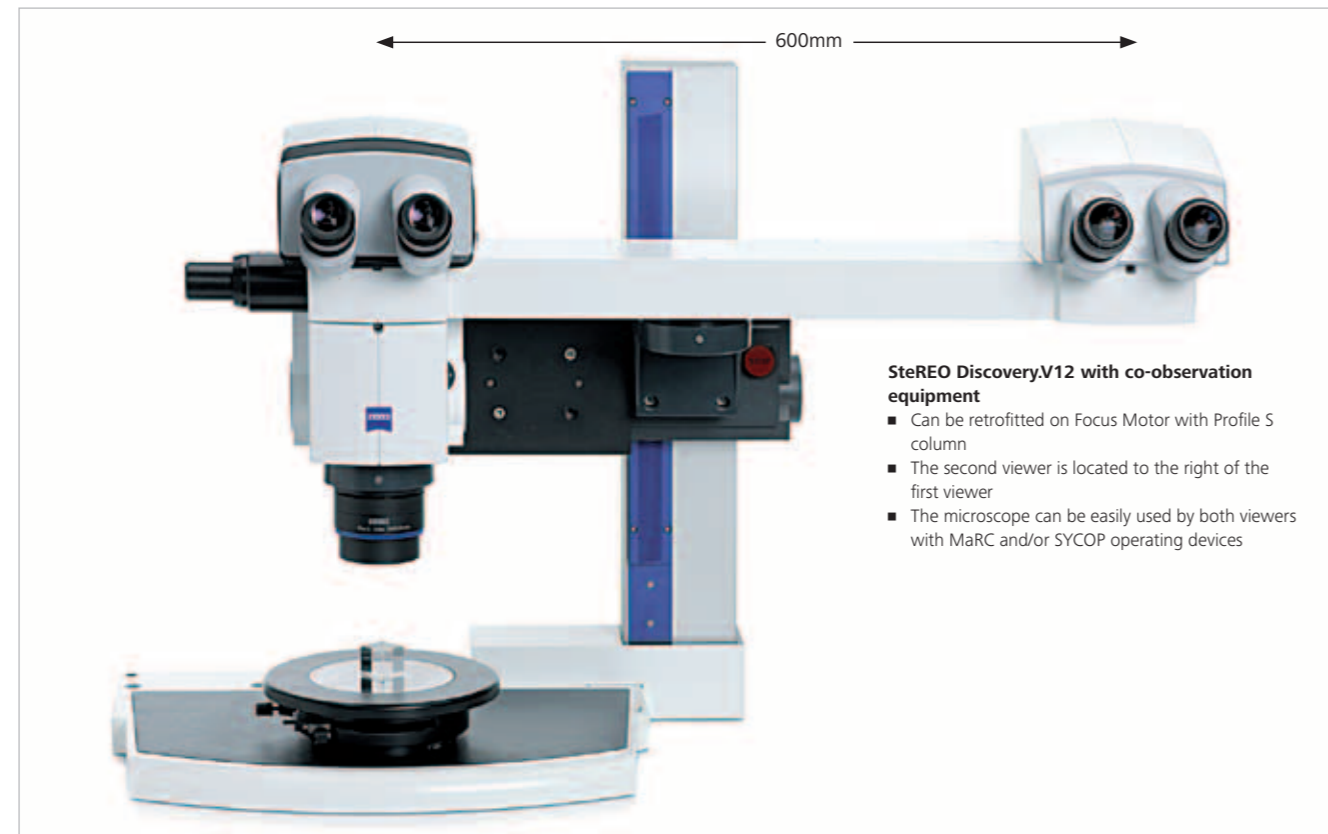

SteREO Discovery.V12 with co-observation equipment

- Can be retrofitted on Focus Motor with Profile S column
- The second viewer is located to the right of the first viewer
- The microscope can be easily used by both viewers with MaRC and/or SYCOP operating devices

Intermediate Tubes



Use the Drawing intermediate tube S to superimpose your pencil on top of the microscopic image, with your drawing surface displayed beneath it.

Choose between manual and motorized intermediate photo tubes, each with a variety of beam-split ratios. Use them to observe with your own eyes, to reproduce images on a monitor, or do both at the same time.



Drawing intermediate tube S

- Superimposes a drawing pencil on the specimen under the microscope, enabling you to see both of them on your drawing surface
- Adjustable-focus lens for adapting to various viewing heights
- Includes telescopic extension for wider stand bases

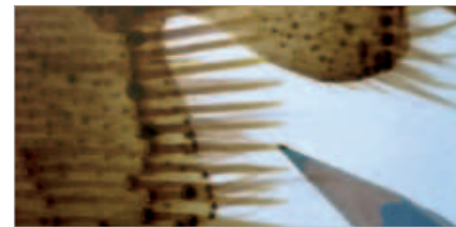

Make perfectly accurate drawings of the objects you are observing.

In addition to our binocular phototubes (page 7), the following intermediate photo tubes are available:

- | | | | |
|---|---|---|--|
| <p>1 Intermediate phototube S, right 3 positions</p> <ul style="list-style-type: none"> ■ 100% observation or ■ 50% observation and 50% camera or ■ 100% camera | <p>2 Intermediate photo tube S mot, right 100/100</p> <ul style="list-style-type: none"> ■ 100% observation or ■ 100% camera | <p>3 Intermediate phototube S, left 100/100</p> <ul style="list-style-type: none"> ■ 100% observation or ■ 100% camera | <p>4 Intermediate phototube S with 2 ports 50:50</p> <ul style="list-style-type: none"> ■ For using two cameras ■ With fixed split ratio for 50% observation and 50% camera |
|---|---|---|--|



Exchangeable Optics



Simply change your objectives by hand. Thanks to the turret's position encoding feature, you can use SYCOP 3 to automatically determine all optical parameters, such as total magnification, field of view, resolution, and depth of field.

The Objective nosepiece S lets you choose between three different objectives, enabling you to adjust your system's optical power as needed for your applications.

Choose between affordable achromatic lenses, high-performance flat-field (plan) achromatic lenses, and premium flat-field (plan) apochromatic lenses.

Achromat S objectives
For high-contrast images of three-dimensional structures.

	PlanApo S 0.63x	PlanApo S 1x	PlanApo S 1.5x	PlanApo S 2.3x	PlanApo S 3.5x	Plan S 1x	Achromat S 0.3x	Achromat S 0.5x	Achromat S 0.63x	Achromat S 1x	Achromat S 1.25x	Achromat S 1.5x
Free working distance (FWD in mm)	81	60	30	10	16	81	253	151	115	69	60	28
Parfocal length (mm)	137	137	137	105	137				137	93	93	93
PlanApo S 0.63x		●	●	○	○	●	○	○	●	○	○	○
PlanApo S 1x	●		●	○	○	●	○	○	●	○	○	○
PlanApo S 1.5x	●	●		×	×	●	○	○		×	×	×
PlanApo S 2.3x	○	○	×		×	○	○	○	○	×	×	×
PlanApo S 3.5x	○	○	×	×		○	○	○	○	○	○	○
Plan S 1x	●	●	●	○	○		○	○	●	○	○	○
Achromat S 0.3x	○	○	○	○	○	○		○	○	○	○	○
Achromat S 0.5x	○	○	○	○	○	○			○	○	○	○
Achromat S 0.63x	●	●	●	○	○	●	○	○		○	○	○
Achromat S 1x	○	○	×	×	○	○	○	○		●	●	
Achromat S 1.25x	○	○	×	×	○	○	○	○		○		●
Achromat S 1.5x	○	○	×	×	○	○	○	○		○	○	●



Objective nosepiece S/doc, 3x, 6x cod
For up to three objectives. If you use parfocal objectives, the region being observed will stay in focus even after the objective is changed.

- These objectives can be combined without any restrictions.
- These objectives can be combined (objectives with different parfocal lengths; need of refocusing after change of objectives)
- × These objectives **cannot** be combined (risk of collision).

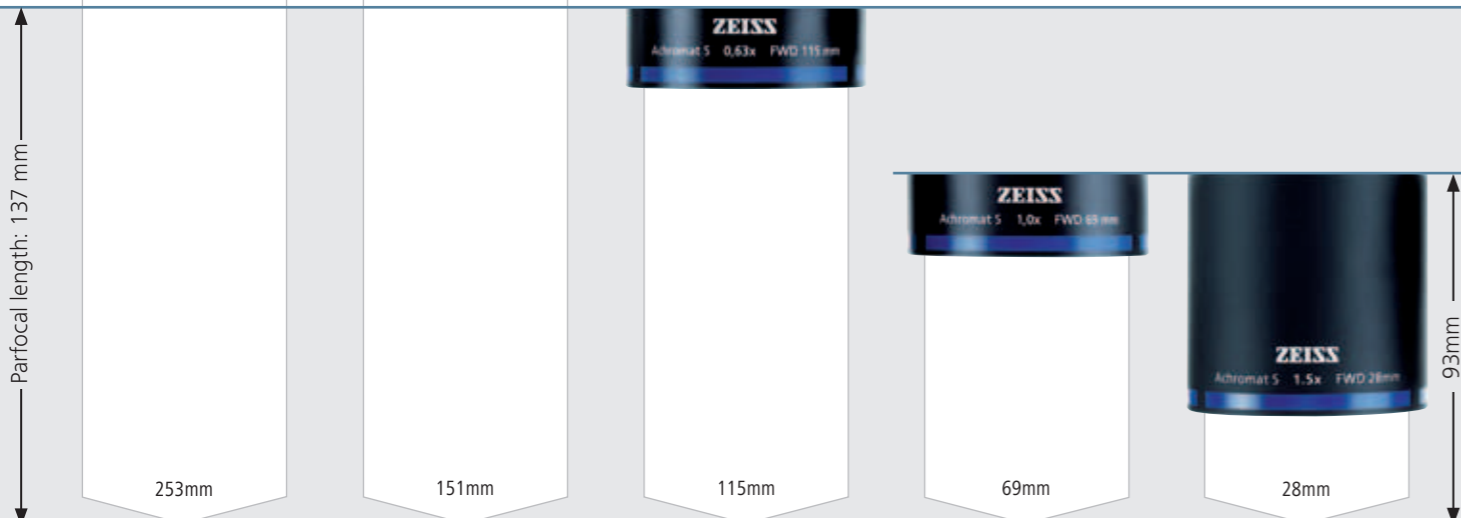
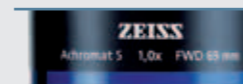

Exchangeable Optics



All eyepieces feature a diopter adjustment (foc.) so that they can be perfectly matched to every individual eye.

ZEISS eyepieces enable you to observe and magnify the intermediate image produced by your microscope's objective, zoom lens system, and tube.

Special eyeglass (Br.) eyepieces allow you to work comfortably – with or without glasses.

Rubber rings protect eyeglasses from damage. Eyecups help place your eyes in the correct position relative to the eyepieces.

Eyepiece E-PL 10x/20 Br. foc. (not pictured)
Affordable wide-field eyepiece (for eyepiece reticles with d = 26 mm)

Eyepiece PL 10x/23 Br. foc.
High-performance standard eyepiece with large flat-field field of view (23 mm), (for eyepiece reticles with d = 26 mm)

Eyepiece PL 16x/16 Br. foc.
Offers high magnification levels with a large viewing angle of 54° (for eyepiece reticles with d = 21 mm)

Eyepiece W 25x/10 Br. foc. (not pictured)
Delivers high magnification levels (for eyepiece reticles with d = 21 mm)

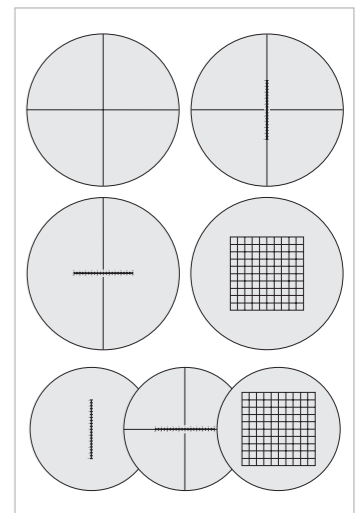

Eyepiece reticles for measuring, counting, and comparing (d = 26 and 21 mm)
Crosshair reticle
Crossline micrometer 10:100
Crossline micrometer 14:140
Net micrometer 12.5x12.5/5; 10
Micrometer 10:100
Crossline micrometer 10:100
Net micrometer 10x10/5; 10

Plan S objectives
Objectives with flat-field correction for observing and documenting particularly flat objects. Ideal for taking measurements.

PlanApo S objectives
Give you the maximum flat-field correction, resolution, and color fidelity.

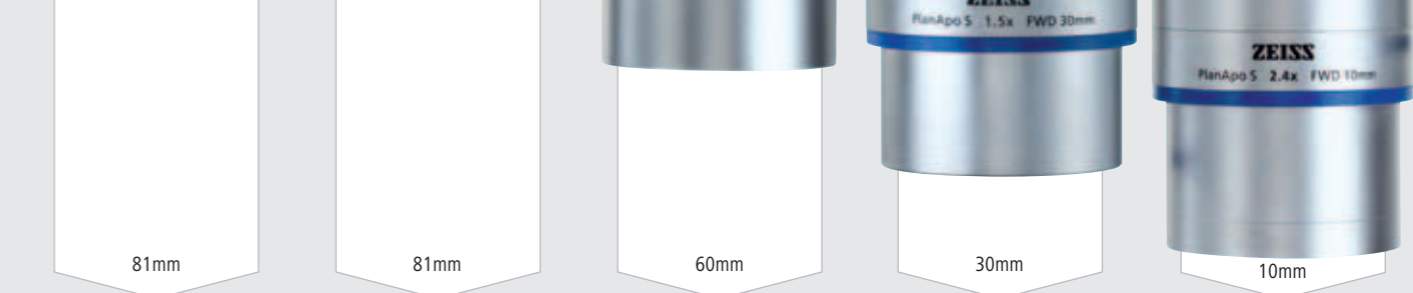
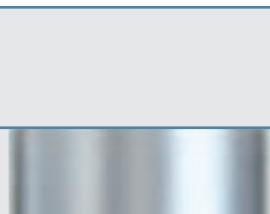

Axial Mode

Carry out precise measurements on microscopic images by observing objects perpendicularly and without any parallax.



When you use axial mode to observe an object through the binocular eyepiece tubes, you first need to move the objective by pushing a button to center it underneath the stereo microscope's right-hand channel. The activated beam-splitter configuration then allows you to observe the microscopic image in 2-D and without any parallax.

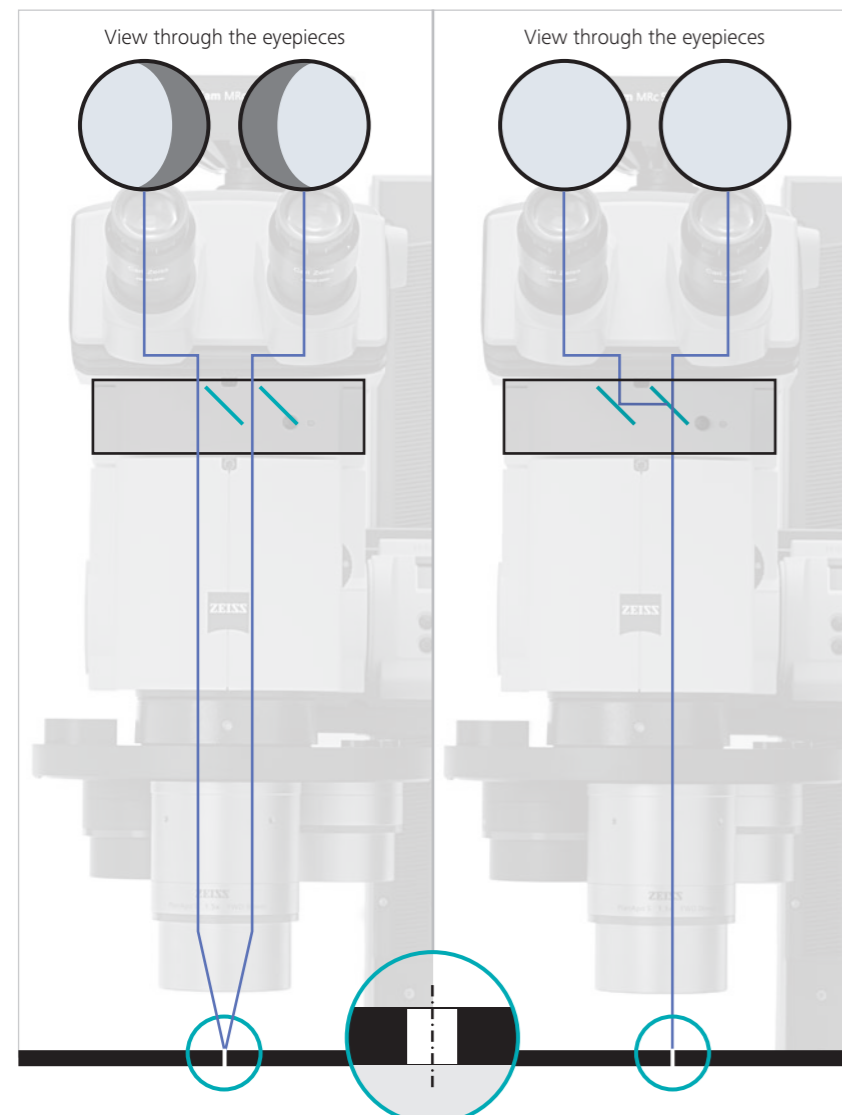

Stereo mode observation

The beam-splitter configuration in intermediate Y tube S mot not active.

When you look through the eyepieces, you will see into the hole at half the stereo angle and the hole wall will block part of your view.

Axial mode observation

When you turn the objective to the axial mode position, the beam-splitter configuration in the intermediate Y tube S mot is automatically switched on, and the same image is seen via both binocular eyepieces. Your line of sight will go straight through the hole, allowing you to see the base without obstruction.



Intermediate Y tube S mot

This equipment splits the microscopic parallax-free image produced in axial mode onto each eyepiece of the binocular tubes.

Objective nosepiece S/doc, 3x, 6x cod

Each of the three positions has an additional encoded axial mode position for parallax-free observation.

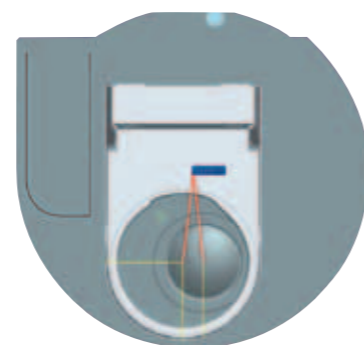

Axial Mode

The PlanApo S 3.5x mono objective and the converter S 1.5x mono both allow you to get even more information from your samples.



Easily switch from stereoscopic observation to a parallax-free view of the object.



Objective on **Objective slider S/doc**

- In axial mode



Tandem mono combination on **Objective slider S/doc**

- For axial mode only



Objective PlanApo S 3.5x mono on **Objective slider S/doc**

- For axial mode only
- Free working distance FWD= 16 mm
- Max. possible resolution of 1,510 LP/mm (equals 0.3 μm)

Objective slider S/doc

Designed to switch the objective between:

- The stereoscopic observation position
- The axial mode position, providing a parallax-free view of the specimen through the stereo microscope's left or right (figure above) observation channel



Converter S 1.5x

■ The Converter S 1.5x increases the magnification and resolution levels in axial mode (tandem mono combination) by a factor of 1.5.

■ The objective's free working distance, on the other hand, stays the same.



Extension rings for objective S mono

■ Adapter for ring light illuminators

■ Objective adapter



Fluorescence Illumination

With fluorescence stereo microscopy you combine fluorescence contrast with large fields of view and three-dimensional images. LED light sources are particularly cost-effective.

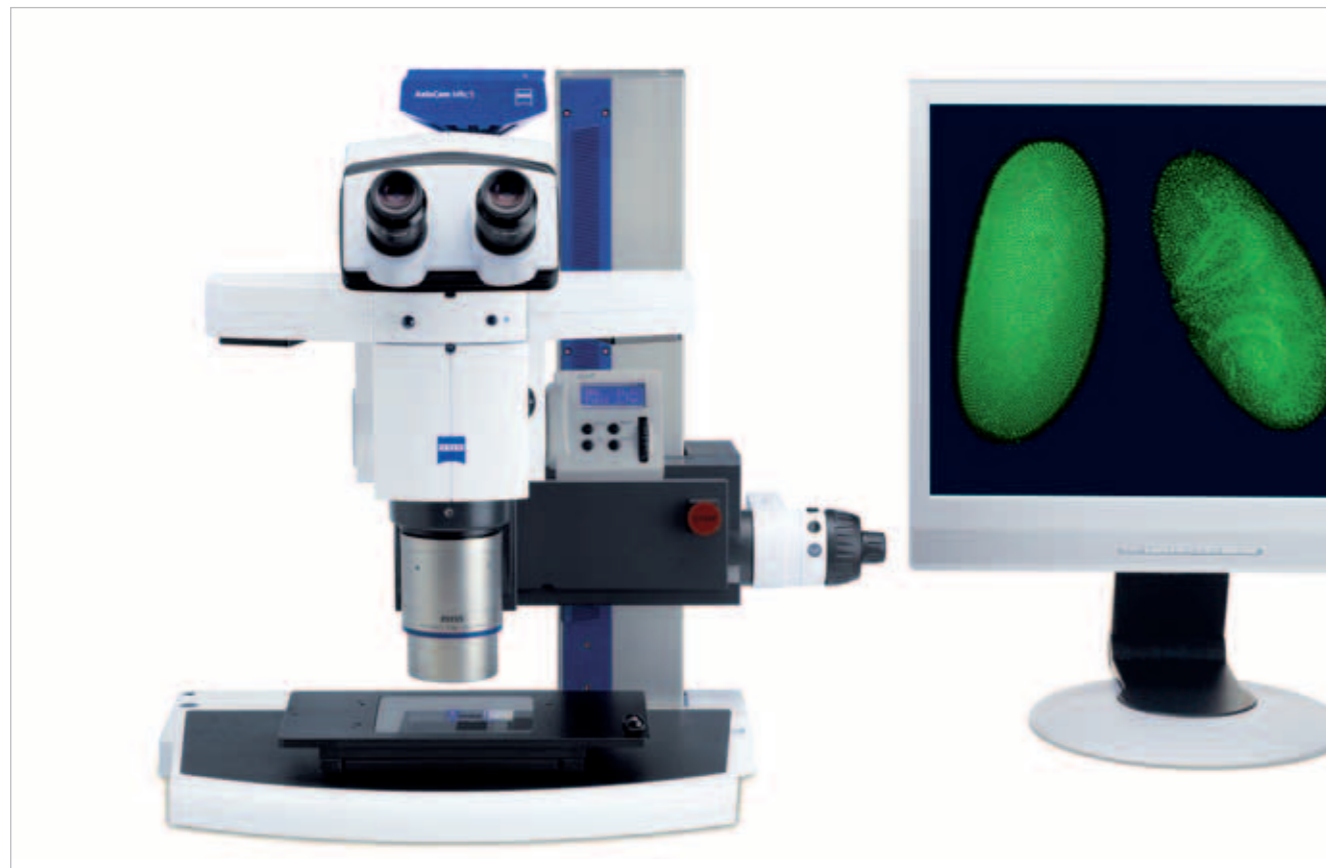

Intermediate LED tubes S provide all the advantages of LED illumination for exciting fluorescence in samples:

- bright homogeneous fluorescence thanks to two coupled LEDs
- Compact components that can be retrofitted
- Up to two tubes can be stacked
- The light can be controlled with SYCOP and/or software

Choose from a variety of tubes:

- Intermediate LED tube FL S, 09 Epodye
- Intermediate LED tube FL S, 14 m RFP
- Intermediate LED tube FL S, 38 HE GFP
- Intermediate LED tube FL S, 46 HE YFP
- Intermediate LED tube FL S, 64 HE mPlum
- Intermediate LED tube FL S, 68 DAPI
- Intermediate LED tube FL S, 69 FITC



Fluorescence Illumination

With coaxial fluorescence illumination you profit from homogeneous and bright excitation of the whole field of view over the entire zoom range.



Changing filter cubes on PentaFluor S is easy. Just pull one out and slide another one in.

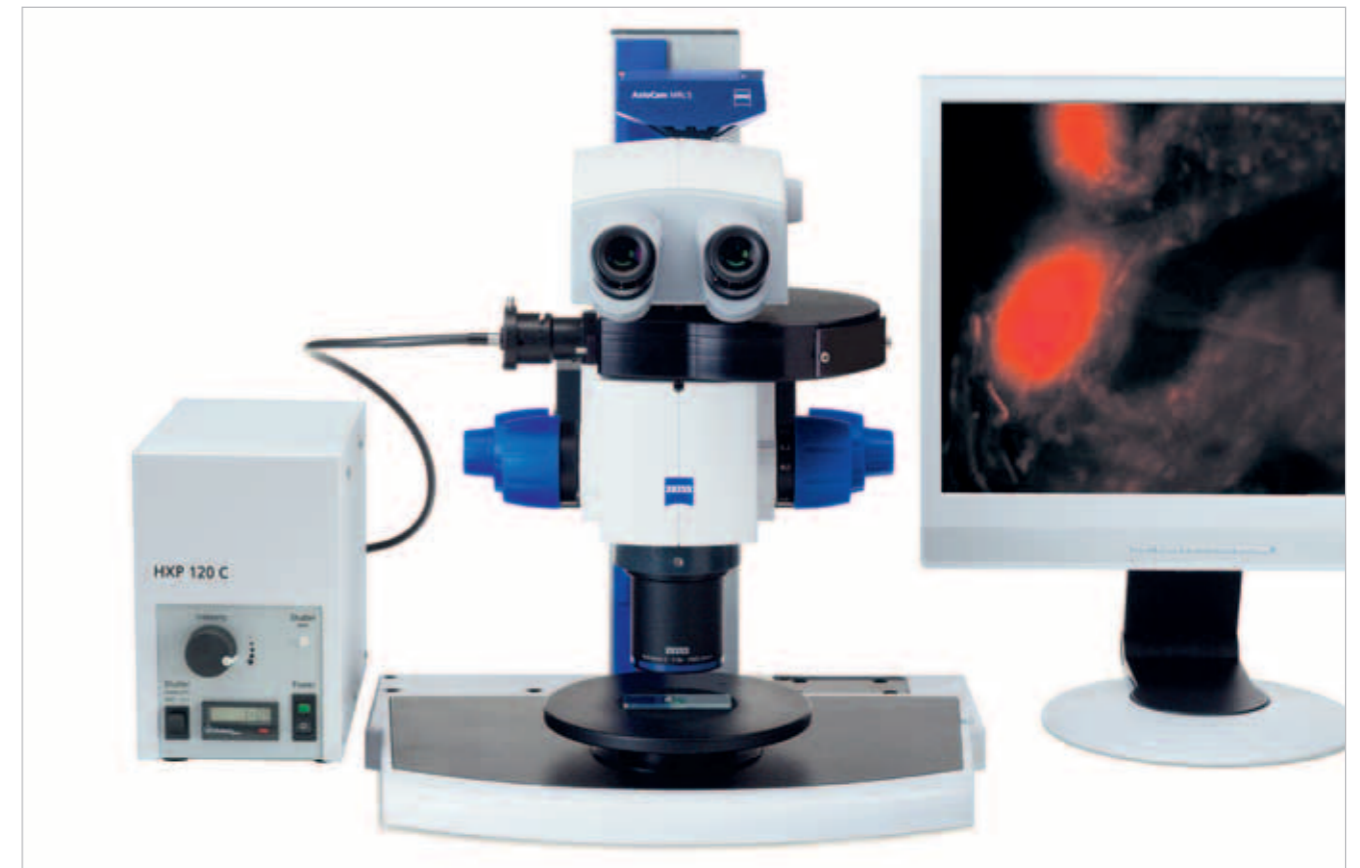

There are two different illuminators available. Each one works with different light sources:

- **PentaFluor S/120 vertical illuminator** for HXP and X-Cite lamps
- **PentaFluor S/HBO vertical illuminator** for HBO 50 and HBO 100 lamps

The vertical illuminator:

- Can be retrofitted on all SteREO Discovery stereo microscopes
- Comes with a turret that can hold up to five filter cubes
- Features a mechanical shutter and an iris for stopping down

Each **filter cube** contains:

- One excitation filter
- Two barrier filters
- Two corresponding beam splitters (See price list for available filter cubes.)



Polarization Contrast

With polarization contrast you examine birefringent materials with your SteREO Discovery, effectively minimizing disruptive reflections.



Indispensable for particle analysis applications, you can adjust the polarized light contrast level on the **Analyzer intermediate tube S mot mono** either automatically or by pressing a button. (see page 59 as well)



For transmitted light examinations in polarized light, the **rotating Pol stage** has a holder for the **polarizer S** and, if desired, can be equipped with a specimen guide 28 x 75 mm and a **lambda plate in a slider** (red-one plate).

The **polarizer S, d = 84 mm**, can also be placed directly in the **transmitted light units** for simple examinations between crossed polarizers in transmitted light.

Accessories for examinations under polarized reflected light:

Polarization filter set
VisiLED/EasyLED for LED ring lights

Polarizer S
for placement in the rotating stage

Analyzer S, rotatable, d = 66 mm
for clamping to objectives

Polarization filter set S, d = 66 mm (not pictured)
for slit-ring illuminators

Polarizer S, d = 84 mm (not pictured)
for placement in transmitted light unit and stages

Lambda plate in slider
for rotating Pol stage

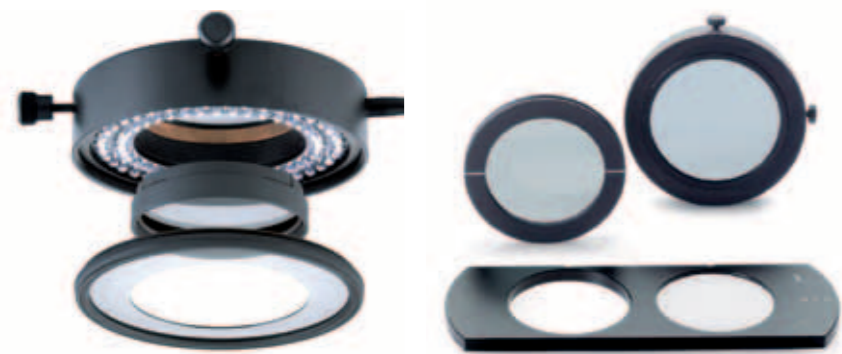

Illuminate shiny surfaces more effectively with rotating **polarizing filters**. Screw them onto the focusing attachments (for light guides with an active area diameter of $d = 4.5$ mm) to minimize disruptive reflections with the **analyzer S**, which is clamped on the objective.



Coaxial Brightfield Epi-Illumination

Use coaxial brightfield epi-illuminators with special polarizing arrangements to see structures clearly even on flat, smooth, reflective surfaces.



A special light coupling point for the slit-ring illuminators allows you to turn the **Objective nosepiece S, coax 3x2 cod**, freely without the light guides getting in the way.



Objective nosepiece S, coax 3x2 cod

- Holds up to three objectives
- A coaxial brightfield epi-illumination can be switched on for each objective position
- Every objective position can be used for stereo observation or axial mode (see pages 12 and 13)
- Has a permanently installed flexible two-arm optical fiber light guide, 4.5/1000 mm for coaxial illumination
- For CL 6000 LED/9000 LED CAN and KL 1500 ECO cold light sources
- All objectives can be equipped with slit-ring illuminators for cold light sources, or with LED ring light illuminators (SLIM lights)

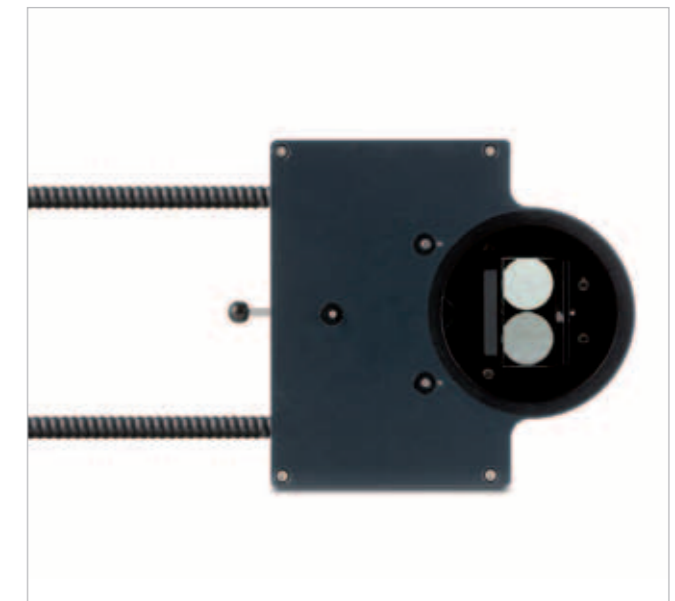

Coaxial epi-illuminator S

- For a single, permanently installed objective
- Illuminator can be retrofitted
- Flexible two-arm optical fiber light guide, 4.5/1000 mm
- For CL 6000 LED/9000 LED CAN and KL 1500 ECO cold light sources

Lambda/4 cap S, d = 66 mm

- Designed to be placed on objectives ($d = 66$ mm)
- Required to produce images in axial mode
- Rotatable

Turning the lambda/4 cap not only reduces reflections on reflective surfaces, but it also optimizes the contrast of the microscopic image.



Technical Specifications

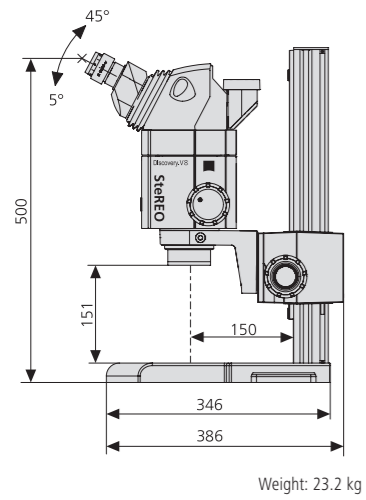

SteREO Discovery.V8

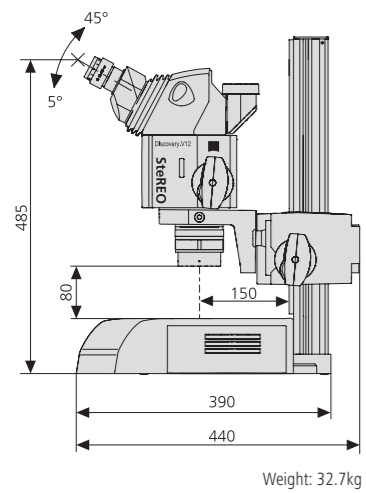

SteREO Discovery.V12

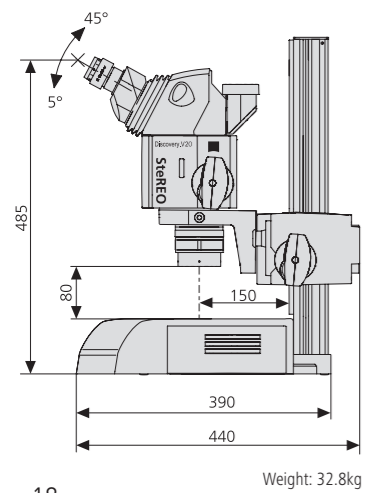

SteREO Discovery.V20

SteREO Discovery

SteREO Discovery.V8

SteREO Discovery.V12

SteREO Discovery.V20

Objectives		Eyepieces					
		WPL 10x/23 Br. foc.		WPL 16x/16 Br. foc.		W 25x/10 foc.	
Designation	Free working distance (FWD in mm)	Magnification	Field of view (mm)	Magnification	Field of view (mm)	Magnification	Field of view (mm)
PlanApo S 0.63x	81	6.3 x ... 50.4 x	36.5 ... 4.6	10.1 x ... 80.6 x	25.4 ... 3.2	15.8 x ... 126 x	15.9 ... 2.0
		5 x ... 63 x	45.6 ... 3.7	8 x ... 100.8 x	28.5 ... 2.3	12.6 x ... 157.5 x	18.3 ... 1.5
		4.7 x ... 94.5 x	48.7 ... 2.4	7.6 x ... 151 x	33.9 ... 1.7	11.8 x ... 236 x	21.1 ... 1.1
PlanApo S 1.0x	60	10 x ... 80 x	23.0 ... 2.9	16 x ... 128 x	16.0 ... 2.0	25 x ... 200 x	10.0 ... 1.3
		8 x ... 100 x	28.8 ... 2.3	12.8 x ... 160 x	18.0 ... 1.4	20 x ... 250 x	11.5 ... 0.9
		7.5 x ... 150 x	30.7 ... 1.5	12 x ... 240 x	21.3 ... 1.1	18.8 x ... 375 x	13.3 ... 0.7
PlanApo S 1.5x	30	15 x ... 120 x	15.3 ... 1.9	24 x ... 192 x	10.7 ... 1.3	37.5 x ... 300 x	6.7 ... 0.8
		12 x ... 150 x	19.2 ... 1.5	19.2 x ... 240 x	12.0 ... 1.0	30 x ... 375 x	7.7 ... 0.6
		11.3 x ... 225 x	20.4 ... 1.0	18 x ... 360 x	14.2 ... 0.7	28.1 x ... 563 x	8.9 ... 0.4
PlanApo S 2.3x	10	23 x ... 184 x	10.0 ... 0.7	36.8 x ... 294.4 x	6.3 ... 0.8	57.5 x ... 460 x	4.0 ... 0.5
		18.4 x ... 230 x	12.5 ... 1.0	29.4 x ... 368 x	7.8 ... 0.6	46 x ... 575 x	5.0 ... 0.4
		17.3 x ... 345 x	13.3 ... 0.7	27.6 x ... 552 x	9.3 ... 0.5	43.1 x ... 863 x	5.8 ... 0.3
PlanApo S 3.5x mono	16	35 x ... 280 x	6.6 ... 0.8	56 x ... 448 x	4.1 ... 0.5	87.5 x ... 700 x	2.6 ... 0.3
		28 x ... 350 x	8.2 ... 0.7	44.8 x ... 560 x	5.1 ... 0.4	70.5 x ... 875 x	3.3 ... 0.3
		26.3 x ... 525 x	8.8 ... 0.4	42 x ... 840 x	5.5 ... 0.27	65.6 x ... 1312.5 x	3.5 ... 0.18
Plan S 1.0x	81	10 x ... 80 x	23.0 ... 2.9	16 x ... 128 x	16.0 ... 2.0	25 x ... 200 x	10.0 ... 1.3
		8 x ... 100 x	28.8 ... 2.3	12.8 x ... 160 x	18.0 ... 1.4	20 x ... 250 x	11.5 ... 0.9
		7.5 x ... 150 x	30.7 ... 1.5	12 x ... 240 x	21.3 ... 1.1	18.8 x ... 375 x	13.3 ... 0.7
Achromat S 0.3x	253	3 x ... 24 x	76.7 ... 9.6	4.8 x ... 38.4 x	53.3 ... 6.7	7.5 x ... 60 x	33.3 ... 4.2
		2.4 x ... 30 x	95.8 ... 7.7	3.8 x ... 48 x	59.9 ... 4.8	6 x ... 75 x	38.3 ... 3.1
		2.3 x ... 45 x	102 ... 5.1	3.6 x ... 72 x	71.1 ... 3.6	5.6 x ... 113 x	44.4 ... 2.2
Achromat S 0.5x	151	5 x ... 40 x	46.0 ... 5.8	8 x ... 64 x	32.0 ... 4.0	12.5 x ... 100 x	20.0 ... 2.5
		4 x ... 50 x	57.5 ... 4.6	6.4 x ... 80 x	35.9 ... 2.9	10 x ... 150 x	23.0 ... 1.8
		3.8 x ... 75 x	61.3 ... 3.1	6 x ... 120 x	42.7 ... 2.1	9.4 x ... 188 x	26.7 ... 1.3
Achromat S 0.63x	115	6.3 x ... 50.4 x	36.5 ... 4.6	10.1 x ... 80.6 x	25.4 ... 3.2	15.8 x ... 126 x	15.9 ... 2.0
		5 x ... 63 x	45.6 ... 3.7	8 x ... 100.8 x	28.5 ... 2.3	12.6 x ... 157.5 x	18.3 ... 1.5
		4.7 x ... 94.5 x	48.7 ... 2.4	7.6 x ... 151 x	33.9 ... 1.7	11.8 x ... 236 x	21.1 ... 1.1
Achromat S 1.0x	69	10 x ... 80 x	23.0 ... 2.9	16 x ... 128 x	16.0 ... 2.0	25 x ... 200 x	10.0 ... 1.3
		8 x ... 100 x	28.8 ... 2.3	12.8 x ... 160 x	18.0 ... 1.4	20 x ... 250 x	11.5 ... 0.9
		7.5 x ... 150 x	30.7 ... 1.5	12 x ... 240 x	21.3 ... 1.1	18.8 x ... 375 x	13.3 ... 0.7
Achromat S 1.25x	50	12.5 x ... 100 x	18.4 ... 2.3	20 x ... 160 x	12.8 ... 1.6	31.3 x ... 250 x	8.0 ... 1.0
		10 x ... 120 x	23.0 ... 1.9	16 x ... 200 x	16.0 ... 1.3	25 x ... 313 x	10.0 ... 0.8
		9.4 x ... 188 x	24.5 ... 1.2	15 x ... 192 x	17.0 ... 0.9	23.5 x ... 469 x	10.6 ... 0.5
Achromat S 1.5x	28	15 x ... 120 x	15.3 ... 1.9	24 x ... 192 x	10.7 ... 1.3	37.5 x ... 300 x	6.7 ... 0.8
		12 x ... 150 x	19.2 ... 1.5	19.2 x ... 240 x	12.0 ... 1.0	30 x ... 375 x	7.7 ... 0.6
		11.3 x ... 225 x	20.4 ... 1.0	18 x ... 360 x	14.2 ... 0.7	28.1 x ... 563 x	8.9 ... 0.4

Axio Zoom.V16

The use of green fluorescent protein (GFP) as a marker for other proteins has had an enduring impact on the evolution of stereo microscopy. With twice the numerical aperture of traditional stereo microscopes, the zoom microscope Axio Zoom.V16 now delivers 2.5 times the resolution and reveals fluorescence with ten times the brightness in comparable fields of view.

You can even apply 3D imaging techniques to entire model organisms. None of these features come at the expense of the Axio Zoom.V16's exceptional stereoscopic viewing effect: simply turn it on and you are ready to go.



reddot design award
winner 2013



Microscope Bodies

Your Axio Zoom.V16 combines a 16x zoom with a high numerical aperture of NA 0.25 in a single system.



You can turn on the stereoscopic viewing effect on the binocular ergo phototube in an instant.

Axio Zoom.V16 microscope body

- Apochromatic optics
 - 0.7x–11.2x motorized zoom (eZoom technology)
 - Maximum NA of 0.25*
 - Electronic click stops
 - Motorized iris
 - Adjustable zoom speed
 - Information on the microscope's magnification, resolution, depth of field, and field of view
 - Diameter for stand mounting: d = 76 mm
- * At maximum zoom level with a 1x objective



The Axio Zoom.V16's eZoom is coupled with a motorized iris: simply press the button for the zoom mode you need.

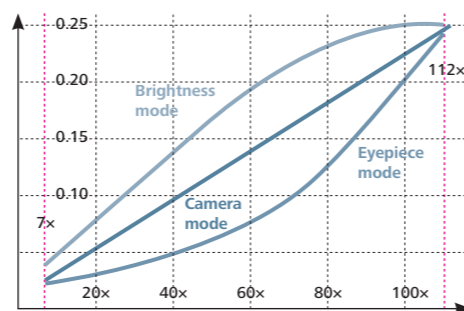

Three different zoom modes ensure you meet your application's requirements:

- 1st zoom mode: Brightness**
Maximum microscopic image brightness throughout the entire zoom range. Ideal for fluorescence microscopy applications.
- 2nd zoom mode: Eyepiece**
Zooming from large fields of view with maximum depth of field in detailed magnification with maximum resolution. Ideal for eyepiece observation with conventional illuminations.
- 3rd zoom mode: Camera**
For the best balance between camera image resolution and depth of field throughout the entire zoom range.



Observation Tubes

Your ZEISS observation tubes deliver dimensionally accurate images with zero chromatic aberration, while ergotubes offer an adjustable viewing angle. All Axio Zoom.V16 observation tubes have a built in camera port.

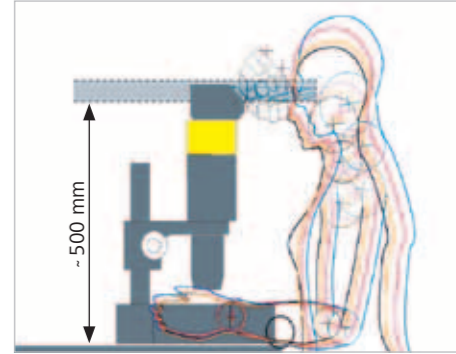

A viewing height of up to 500 mm combined with a viewing angle of 20° – the recommended way to avoid tension and neck pain.

- 1 Binocular ergo phototube Z 0-30° mot**
 - 0-30° adjustable viewing angle
 - Tilting eyepiece tubes for two viewing heights
 - 55–75 mm adjustable interpupillary distance
 - 100/100 photo port; switchable, motorized
 - Slider for stereoscopic observation
- 2 Binocular phototube Z 15°**
 - Fixed 15° viewing angle
 - Tilting binocular section for two viewing heights
 - 55–75 mm adjustable interpupillary distance
 - 100/100 photo port; switchable
- 3 Phototube Z 100:0**
 - Fixed 100% photo tube
- 4 Camera tube Z, 5 MP**
 - Without eyepieces
 - With integrated 5MP CCD camera

For simple configurations in reflected-light, use the **spacer tube Z 40 mm** to achieve an ergonomic viewing height.

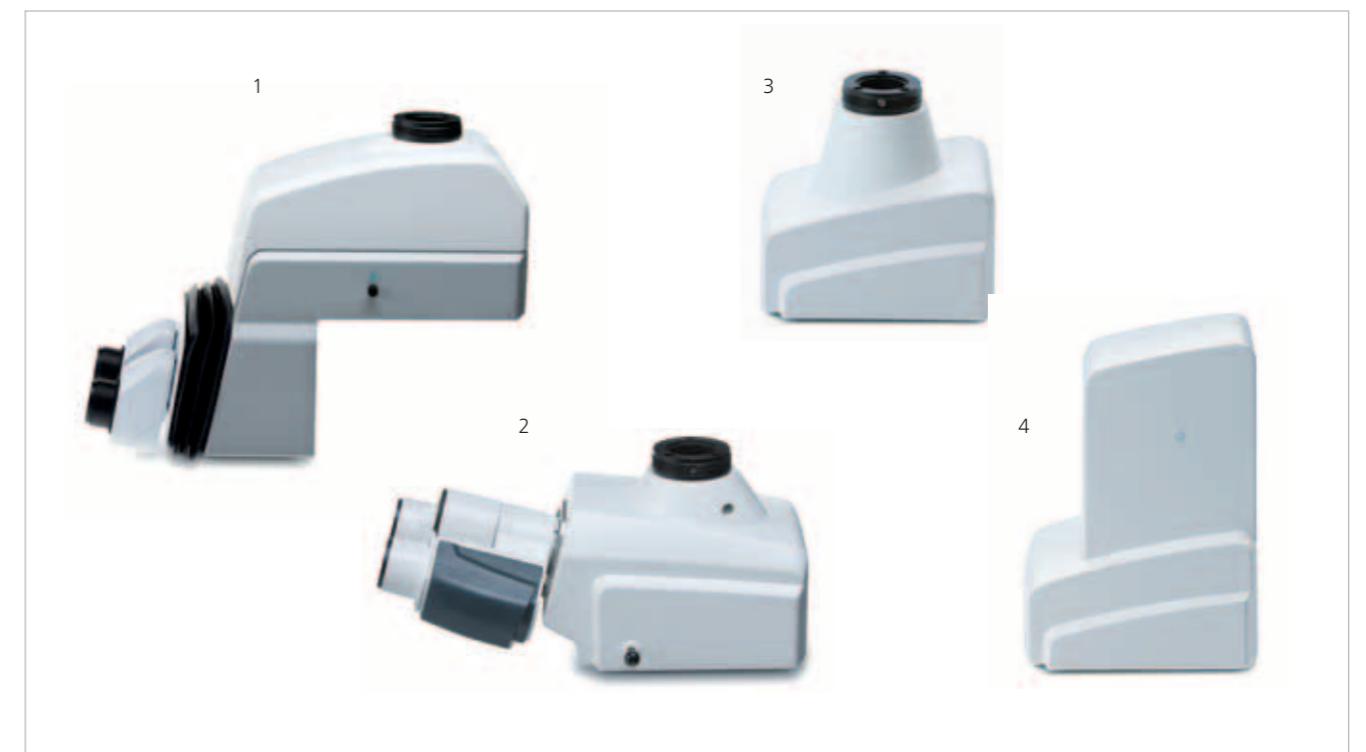

Exchangeable Optics

Objectives are not only a microscope's eyes, but are also a decisive factor in the quality of its microscopic images. This is why ZEISS uses all available resources to create flawless objectives.



The Objective nosepiece Z, 2x cod you to change objectives quickly and conveniently. Thanks to the turret's position-encoding feature, you can use SYCOP 3 to automatically read optical parameters such as magnification, field of view diameter, resolution, and depth of field. In addition, you can focus non-parfocal objectives automatically with the Focus Motor after activating the Parfocality Manager feature.



Objective nosepiece Z, 2x cod

- Accommodates two objectives
- Encoded objective positions

Use parfocal objectives – when you change them, they will ensure that your image stays in focus.

For Axio Zoom.V16 choose between:

PlanApo Z objectives

- Achromatic objective with excellent flat-field correction
- Consistently sharp images with no chromatic aberration
- The professional choice for the best possible image quality



114mm



60mm

Parfocal length: 164 mm

Exchangeable Optics

ZEISS eyepieces enable you to observe and magnify the intermediate image produced by your microscope's objective, zoom system, and tube lens. Special eyeglass (Br.) eyepieces allow you to work comfortably – with or without glasses.



All eyepieces feature a diopter adjustment (foc.) so that they can be perfectly matched to every individual eye.

Rubber rings protect eyeglasses from damage.

Eyecups help place your eyes in the right position relative to the eyepieces.

Eyepiece E-PL 10x/20 Br. foc. (not pictured)

Affordable wide-field eyepiece (for eyepiece reticles with $d = 26$ mm)

Eyepiece PL 10x/23 Br. foc.

High-performance standard eyepiece with large flat-field field of view of 23 mm (for eyepiece reticles with $d = 26$ mm)

Eyepiece PL 16x/16 Br. foc.

For high magnification levels with a large viewing angle of 54° (for eyepiece reticles with $d = 21$ mm)

Eyepiece W 25x/10 Br. foc. (not pictured)

For high magnification levels (for eyepiece reticles with $d = 21$ mm)

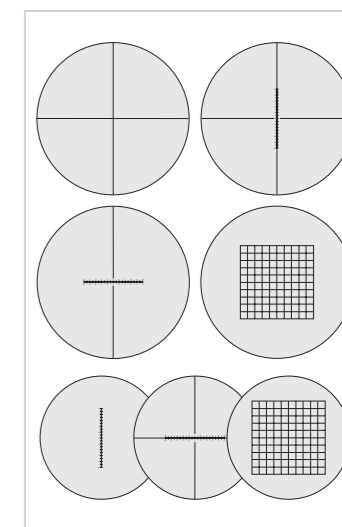

Eyepiece reticles for measuring, counting, and comparing ($d = 26$ and 21 mm)

Crosshair reticle

- Crossline micrometer 10:100
- Crossline micrometer 14:140
- Net micrometer 12.5x12.5/5; 10
- Micrometer 10:100
- Crossline micrometer 10:100
- Net micrometer 10x10/5; 10

Apo Z 1.5x objectives

- Achromatic objective
- Optimal balance between resolution and free working distance
- Ideal for manipulation and microsampling



30mm

Parfocal length: 133mm



56mm

PlanNeoFluar Z objectives

- Achromatic objective
- Excellent price/performance ratio
- Recommended for fluorescence applications



10.6mm

Parfocal length: 105mm

Fluorescence Illumination

With twice the numerical aperture of stereo microscopes, your Axio Zoom.V16 reveals fluorescence with ten times the brightness in comparable fields of view.

HXP 200 C illuminator

- Compact, powerful, low-noise light source with 200 W mercury short-arc reflector lamp
- Integrated electronic shutter
- Five-stage dimmer
- 2,000 h lamp life (on average)
- 1.5 m liquid light guide with high transmittance



Fluar illuminator Z mot

- Intermediate fluorescence tube can be retrofitted; encoded
- Motorized reflector turret for up to four Z reflector modules
- Automatic reflector module detection (ACR)
- Motorized shutter
- Mount for stop slider or ApoTome.2 imaging system
- Designed to house HXP 200 C illuminator light guides
- Cover with automatic light-off mechanism



Push and click: Z reflector modules can be quickly and easily inserted into the Z Fluar illuminator.



There are three different Z reflector modules available. Each is equipped with an excitation filter, an emission filter, and a beam splitter at the factory:

Reflector module Z FL P&C

- No encoding

Reflector module Z FL ACR P&C

- Factory-set encoding

Reflector module Z FL ACR RW P&C

- With customizable encoding

Stop slider, man (left)

Stop slider, mot (right)

- Integrated electronic shutter



Fluorescence Illumination

You can use Axio Zoom.V16 for tasks that range from routine screening to sophisticated imaging applications in biology, medicine, and forensics.

ApoTome.2 allows you to obtain artifact-free optical sections in fluorescence imaging applications.



ApoTome.2 slider

- Structured illumination for producing optical sections in fluorescence applications
- Can be retrofitted
- Comes with three grids (low, medium, high) for using the zoom range (for 40x and higher total magnification)



Slide the ApoTome.2 module into its working position: an acoustic signal will indicate when the slider is in the right position. The ZEN imaging software will take care of the rest for you.

Coaxial Brightfield Epi-Illumination

Enjoy excellent contrast and minimize reflections when examining smooth or shiny surfaces.



Use the slider to turn off the coaxial epi-illumination. Use this free position for other illumination methods.

Lambda/4 cap S

- Designed to be placed on the front of objectives with $d = 66 \text{ mm}$
- Required to produce an image under coaxial reflected light
- Rotatable

Turning the lambda/4 cap not only reduces reflections on reflective surfaces, but it also optimizes the contrast of the microscopic image.



Epi-illuminator Z

- Intermediate tube can be retrofitted
- Recommended for PlanApo Z objective
- A sliding lever for turning coaxial reflective light illumination on and off
- Slider for applying a relief effect to the projected coaxial incident light if desired
- Permanently installed flexible optical fiber light guide, 8/1000 mm
- For CL 6000 LED/9000 LED CAN and KL 1500 ECO cold light sources

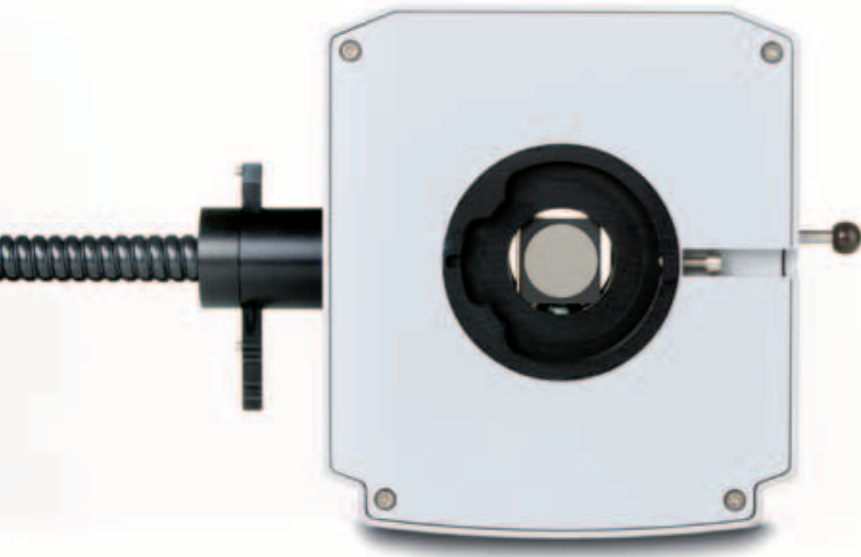

Coaxial Brightfield Epi-Illumination

Use the relief effect with coaxial reflected light to clearly bring out fine structures on the surface of your sample – especially at high magnification levels.



By changing the angle of the oblique reflected light, you can bring out textures and small steps on smooth surfaces – especially at high magnification levels.

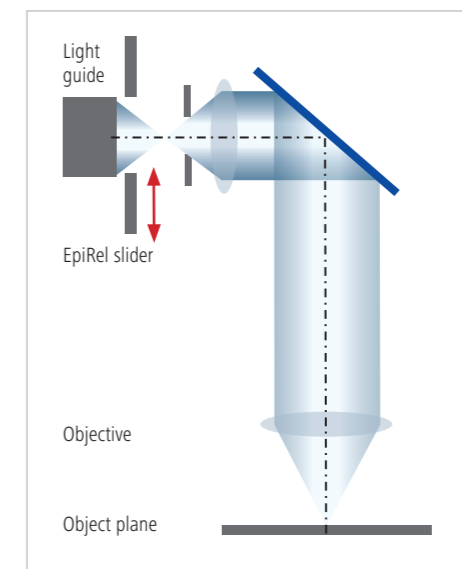

Position 1:
 ■ EpiRel slider at "relief contrast" end position (left)
 ■ This end position is available in both directions
 ■ Direction of illumination tilted 1°



Position 2:
 ■ EpiRel slider in "coaxial reflected brightfield illumination" detent
 ■ Perfectly perpendicular direction of illumination

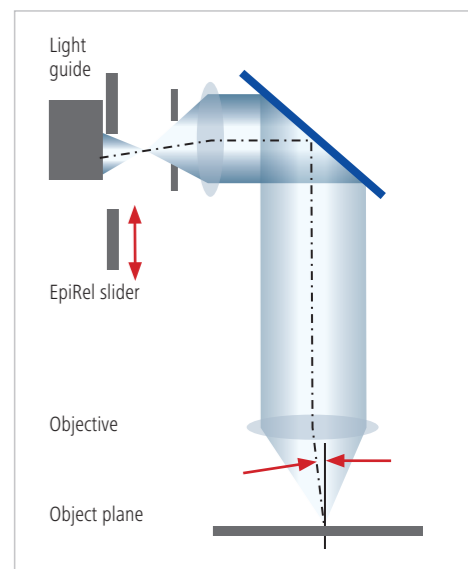

Position 3:
 ■ EpiRel slider at "relief contrast" end position (right)
 ■ This end position is available in both directions
 ■ Direction of illumination tilted 1°

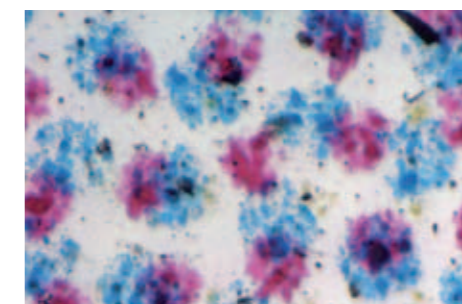

This color print on a DVD clearly features higher contrast levels with oblique illumination in position 1 or 3 (picture, right) than with traditional coaxial illumination in position 2 (picture, left).

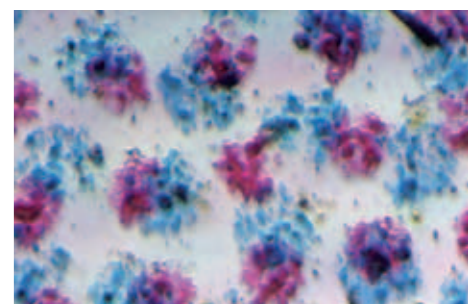

Technical Specifications

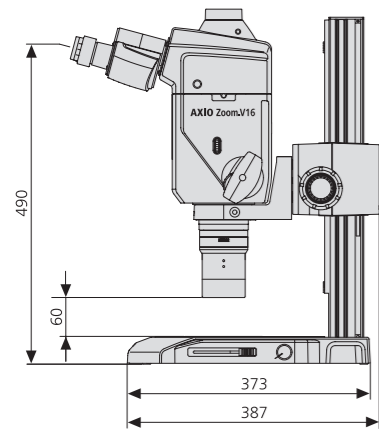

Weight: 22.6kg

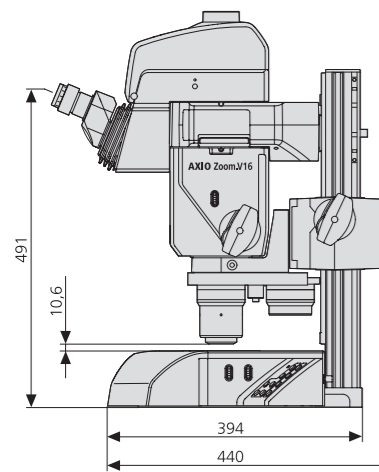
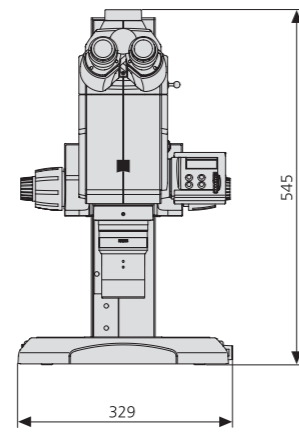

Weight: 38.3kg

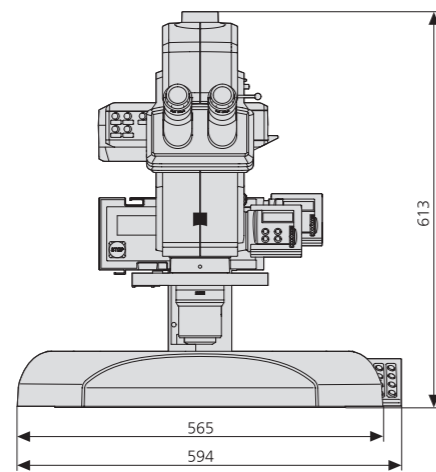

Objectives		Eyepiece WPL 10x/23 Br. foc.			
Designation	FWD	Magnification	Field of view	Resolution	Depth of field
PlanApo Z 0.5x	114 mm	3.5 x ... 56 x	66 mm ... 4.1 mm	10 µm ... 1.3 µm	2.0 mm ... 36 µm
PlanApo Z 1.0x	60 mm	7 x ... 112 x	33 mm ... 2.0 mm	5.0 µm ... 0.7 µm	0.5 mm ... 9.0 µm
Apo Z 1.5x	30 mm	10.5 x ... 168 x	22 mm ... 1.4 mm	3.3 µm ... 0.4 µm	0.2 mm ... 4.0 µm
PlanNeoFluar Z 1.0x	56 mm	7 x ... 112 x	33 mm ... 2.0 mm	5.0 µm ... 0.7 µm	0.5 mm ... 9.0 µm
PlanNeoFluar Z 2.3x	10 mm	16 x ... 258 x	14 mm ... 0.9 mm	2.1 µm ... 0.3 µm	90 µm ... 2.0 µm

		Eyepiece PL 16x/16 Br. foc.			
		Magnification	Field of view	Resolution	Depth of field
PlanApo Z 0.5x	114 mm	5.6 x ... 90 x	46 mm ... 2.9 mm	10 µm ... 1.3 µm	2.0 mm ... 36 µm
PlanApo Z 1.0x	60 mm	11.2 x ... 180 x	23 mm ... 1.4 mm	5.0 µm ... 0.7 µm	0.5 mm ... 9.0 µm
Apo Z 1.5x	30 mm	16.8 x ... 270 x	15 mm ... 1.0 mm	3.3 µm ... 0.4 µm	0.2 mm ... 4.0 µm
PlanNeoFluar Z 1.0x	56 mm	11 x ... 179 x	23 mm ... 1.4 mm	5.0 µm ... 0.7 µm	0.5 mm ... 9.0 µm
PlanNeoFluar Z 2.3x	10 mm	26 x ... 410 x	9.9 mm ... 0.6 mm	2.1 µm ... 0.3 µm	90 µm ... 2.0 µm

Accessories

The modular design of ZEISS stereo- and zoom microscopes allows you to benefit from a sophisticated system of interfaces and adapters, giving you maximum flexibility as you adapt your microscope to your needs.



Manual Stands



Use the **coarse/fine drive with profile column 490 mm** to focus equipment weighing up to 10 kg.

Use vibration-resistant, rigid stands to unlock resolutions of up to 1,000 LP/mm with your powerful stereo microscopes.

All ZEISS stands feature microscope holders with $d = 76$ mm, a focus range of 340 mm, and M8 holes for mounting optional accessories. Depending on the specific application, they come with a glass or black/white plastic plate, $d = 120$ mm.

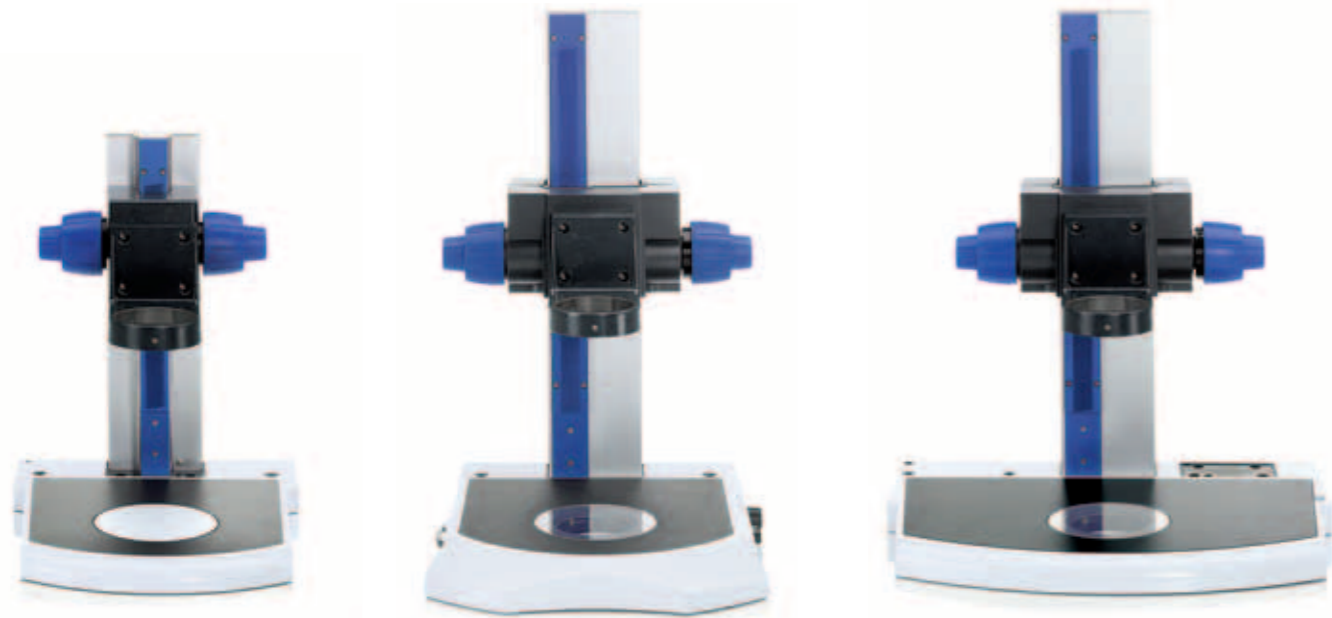

Manual stand 300
Coarse/fine drive with T-column 350 mm on Base 300 for epi-illumination

- Foot print: 290 × 350 mm (h = 26 mm)
- Can hold VisiLED transmitted light brightfield system (d = 84 mm)
- Profile T column: h = 350 mm
- Max. load capacity: 10 kg

Manual stand 300
Coarse/fine drive with profile column 490 mm on Transillumination base 300

- Foot print: 320 × 370 mm (h = 42 mm)
- Integrated transmitted light illumination (brightfield, oblique illumination, darkfield)
- Profile S column: h = 490 mm
- Connection for objective nosepiece
- Max. load capacity: 12 kg

Manual stand 450
Coarse/fine drive with profile column 490 mm on Transillumination base 450

- Foot print: 450 × 300 mm (h = 31 mm)
- 410 × 250 mm insert plate
- Can hold VisiLED transmitted light brightfield (d = 84 mm)
- Profile S column: h = 490 mm
- Connection for objective nosepiece
- Max. load capacity: 12 kg

These FEM models show possible stand base deformation scenarios for a microscope configuration weighing 17 kg.

Ribbed die-cast parts in conventional stand bases (fig. 1) undergo significantly heavier deformation than the new stand bases 300 and 450 (fig. 2), which are designed as milled parts.

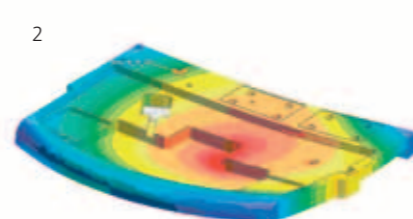
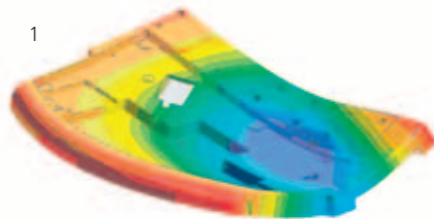

Stands

Motorized Stands

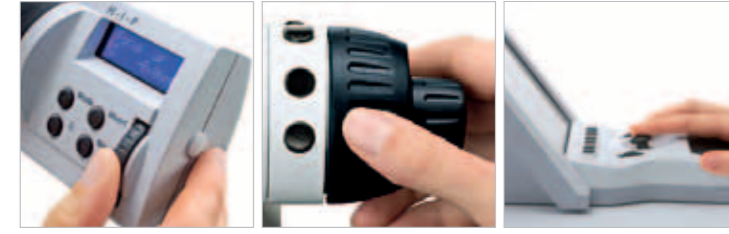

Use the scroll wheel on **HIP** (left), the control knob on **MaRC** (center), or the joystick on **SYCOP** (right) to focus on your image.

Motorized stands provide excellent rigidity and precision coupled with speed and reproducibility.

Focus Manager, specimen protection, and easy Z-axis measurements come as standard with Focus Motor 3 and can be activated individually on SYCOP 3.

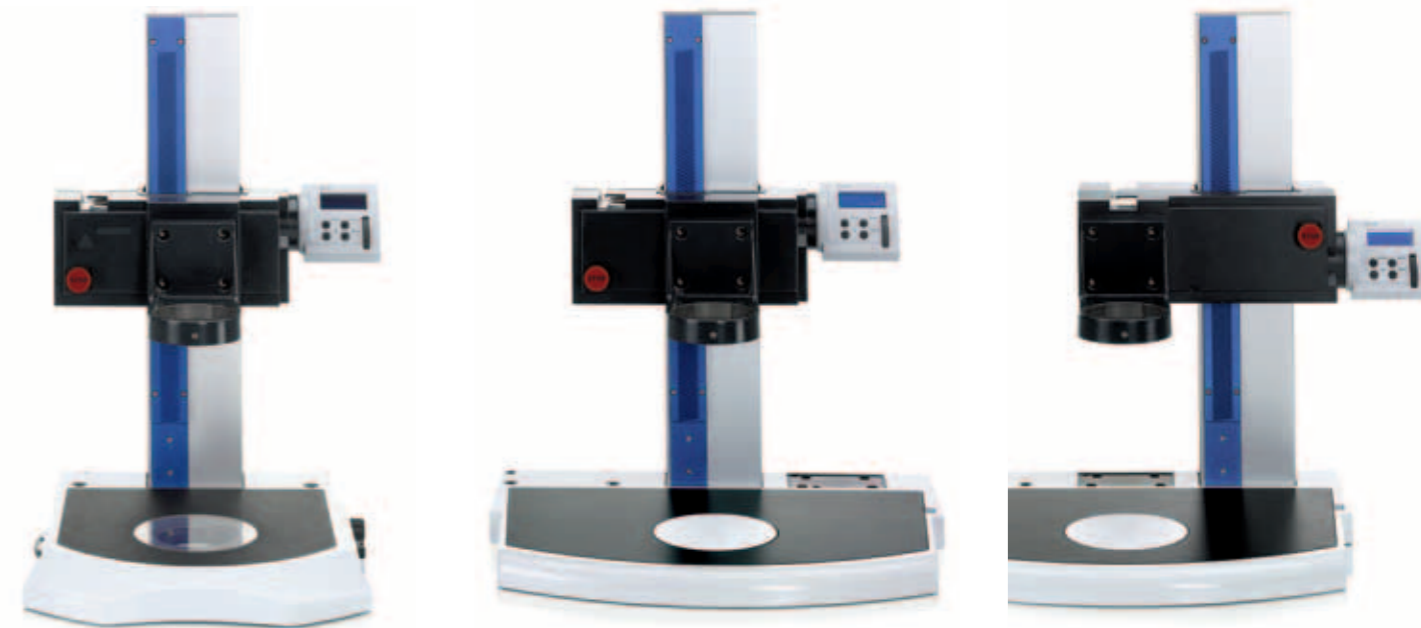

Motorized stand 300
Focus motor 3 with central profile column 490 mm on Transillumination base 300

- Foot print: 320 × 370 mm (h = 42 mm)
- Integrated transmitted light illumination (brightfield, oblique illumination, darkfield)
- Profile S column: h = 490 mm
- Minimum focus increment distance: 350 nm
- Operated with HIP and/or MaRC and/or SYCOP 3 and/or software
- Connection for objective nosepiece
- Max. load capacity: 17 kg

Motorized stand 450
Focus motor 3 with central profile column 490 mm on stand base 450

- Foot print: 450 × 300 mm (h = 31 mm)
- 410 × 250 mm insert plate
- Can hold VisiLED transmitted light brightfield (d = 84 mm)
- Profile S column: h = 490 mm
- Minimum focus increment distance: 350 nm
- Operated with HIP and/or MaRC and/or SYCOP 3 and/or software
- Connection for objective nosepiece
- Max. load capacity: 17 kg

Motorized stand 450
Focus motor 3 with profile column 490 mm on stand base 450

- Foot print: 450 × 300 mm (h = 31 mm)
- 410 × 250 mm insert plate
- Can hold VisiLED transmitted light brightfield (d = 84 mm)
- Profile S column: h = 490 mm
- Minimum focus increment distance: 350 nm
- Operated with HIP and/or MaRC and/or SYCOP 3 and/or software
- Connection for objective nosepiece
- Max. load capacity: 17 kg

Focus motor 3 with central profile column 490 mm on Base 300 for epi-illumination (not pictured)

- Foot print: 290 × 350 mm (h = 26 mm)
- Can hold VisiLED transmitted light brightfield (d = 84 mm)
- Profile T column: h = 350 mm
- Max. load capacity: 10 kg

Gliding, Rotating, and Ball-and-Socket Stages

Choose from a variety of stages that will make it easy to move your specimens gently during observation.

Gliding stage S 110 x 110, d = 120 mm

For moving large specimens in reflected and transmitted light. Comes with a 116 x 116 mm glass insert plate.

- Travel range: 110 x 110 mm
- Adjustable blocking
- Stand mount: d = 120 mm
- Alternatively to glass insert plate: 116 x 116/84 mm mounting frame for stage diagrams with d = 40 mm opening, d = 25 mm opening, black/white plastic plate



Gliding stage

For moving and positioning specimens under reflected and transmitted light.

- Stage diameter: d = 190 mm
- Travel range: +/- 20 mm
- Insert plate: d = 84 mm
- Stand mount: d = 84 mm or d = 120 mm (adapter needed)

Ball-and-socket stage

Can be tilted and turned in any direction: ideal for observing 3D objects from all directions.

Preferably use with reflected light. The exchangeable **adherently coated plate, d = 84 mm** allows specimens to be affixed.

- Stage diameter: d = 158 mm
- Insert plate: d = 84 mm (adherently coated)
- Tilting range: +/- 30°
- Stand mount: d = 84 mm or d = 120 mm (adapter needed)

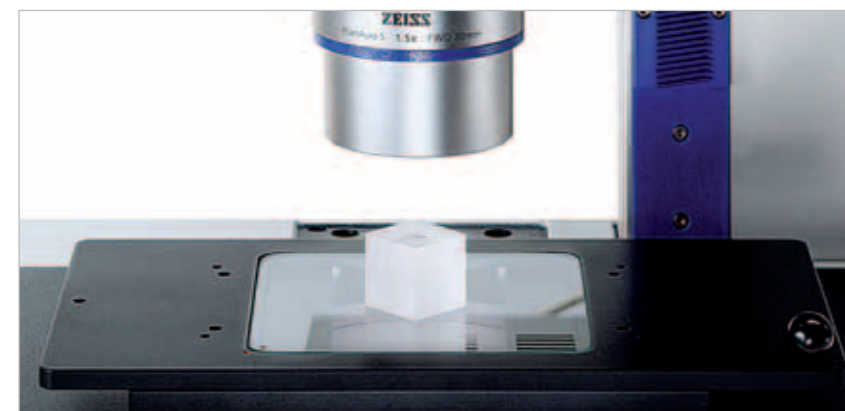

Rotating Pol stage for transmitted- and reflected-light for precise specimen rotation.

- Stage diameter: d = 115 mm
 - Rotating range: graduated 360°
 - Stand mount: d = 84 mm
- Can be retrofitted with an objective guide:
- Adjustment range: 75 x 25 mm

Additional accessories for polarization in transmitted light:

- Polarizer S, d = 84 mm
- Lambda plate in a slider

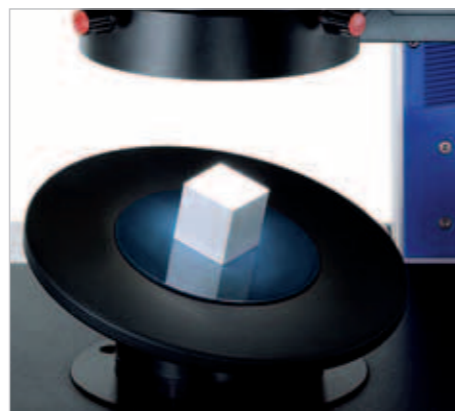
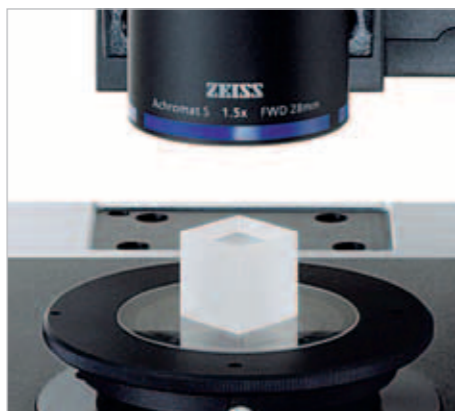

Stages

Mechanical Stages

These stages allow you to control your specimens with the utmost precision. Use motorized stages to work quickly, with pinpoint accuracy and guaranteed reproducibility.



Controlled specimen movement: joystick on SYCOP 3.

These low-profile three-plates mechanical stages with large travel ranges have been developed specifically for stereo- and zoom microscopes. They are compatible with all stands 300 and 450 and can be used for all transmitted light techniques.

- Stand mount: d = 120 mm
- Travel range: 150 x 100 mm
- Insert plates S: metal, 237 x 157 x 3 mm
glass, 237 x 157 x 3 mm
(additional inserts and adapter plates available upon request)
- Max. load capacity: 3 kg

Mechanical stage S 150x100 R on stand base 450

- Controlled with horizontal coaxial drive on the right

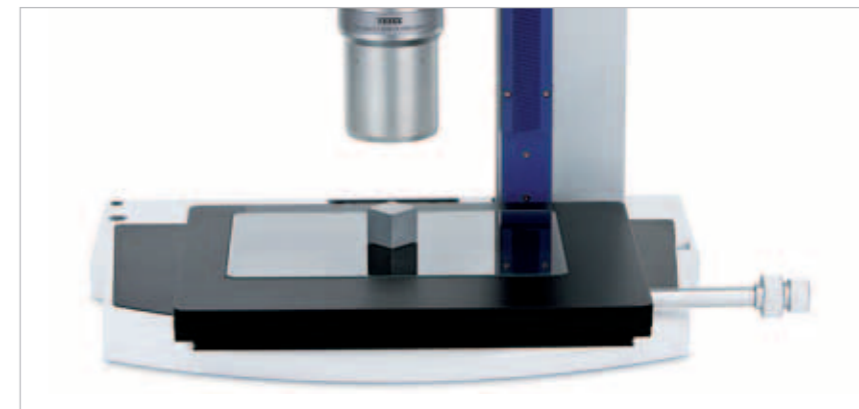

Mechanical stage S 150x100 mot; CAN on Transillumination top 450 mot

- Controls: SYCOP 3, mobile coaxial drive XY; CAN, ZEN, or AxioVision
- Travel speed: max. 17 mm/sec
- Positioning accuracy: 20 µm
- Reproducibility: < 1 µm



Mechanical stage S 150x100 mot; CAN on stand base 450 (not pictured)

- Controls: SYCOP 3, mobile coaxial drive XY; CAN or ZEN
- Travel speed: max. 17 mm/sec
- Positioning accuracy: 20 µm
- Reproducibility: +/- 2 µm

Additional stage inserts:

Adapter frame S 160 x 116 mm

- For mounting frames 160 x 116 mm
- For specimen holders for conventional and correlative particle analysis (pictured on the right) and Shuttle & Find



Insert plate Slides/Tubes 6x 237x157 mm

- Accommodates four slides and one tube holder
- For isolating and saving fine particles and cells with microspheres (pages 48 and 49)



Reflected Light with Fiber Optics

Cold light sources are the perfect way to illuminate your samples with high intensity and low heat input.

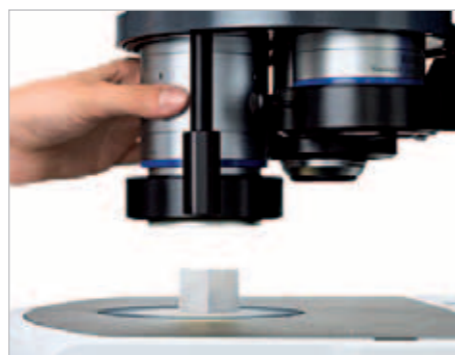

Special slit-ring illuminators for the objective nosepiece make it easy to change objectives without any cables or flexible light guides getting in the way.



- Single arm spot illuminators** – Variable oblique illumination with targeted shadow effect
- Flexible or gooseneck light guide
 - Active area diameters of $d = 5\text{ mm}$ or $d = 8\text{ mm}$
 - Focussing attachments for better light bundeling on specimen
 - Flexible light guide 1500, 8/1000 mm** with **Focussing attachment $d = 8\text{ mm}$** on **Illuminator carrier S, M8-M8** (Fig. left)

Diffuse facelight M8
Indirect, soft oblique illumination prevents outshining reflections



- Dual arm spot illuminators** – Variable oblique illumination for reducing disruptive hard shadows.
- Flexible or gooseneck light guides
 - active area diameter of $d = 4.5\text{ mm}$ or $d = 5.6\text{ mm}$
 - Focussing attachments
 - Flexible light guide 1500, 2x5.6/1000 mm** with **Focussing attachment $d = 8\text{ mm}$** on **Illuminator carrier S, M8-M8** (Fig. left)

Line light S, l=50 mm
Turns the light guide's circular cross section into a narrow fiber-optic slit. The light, which is projected at an extremely flat illumination angle, strikes the top of the specimen at a flat angle, and the corresponding shadow effect makes even the smallest surface structures become visible. Also well-suited for use with objectives with short working distances.



- Slit-ring illuminator**
Ideal for homogeneous and shadow-free illumination on large-scale objects.
- With flexible light guides
 - With an active area diameter of $d = 9\text{ mm}$

- Slit-ring illuminator, $d = 66\text{ mm}$, for use with objective nosepiece**
- With flexible light guides with active area diameter of $d = 9\text{ mm}$
 - Light conducting rods (13 mm or 51 mm) to connect light guide with ring light

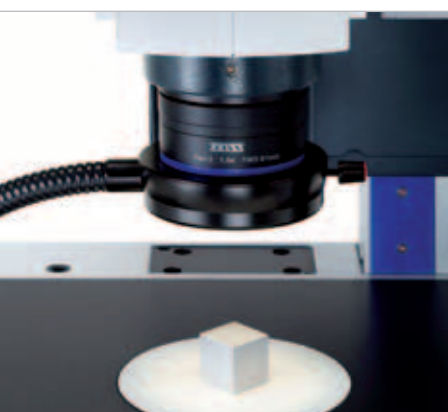

Illumination

Reflected Light with Fiber Optics

Different applications require different types of illumination. Choose between a range of fiber-optic components.



The **Objective nosepiece S, coax 3x2 cod** combines coaxial brightfield epi-illumination with a three-lens objective nosepiece. The coaxial illumination feature can be switched easily via pull rod.

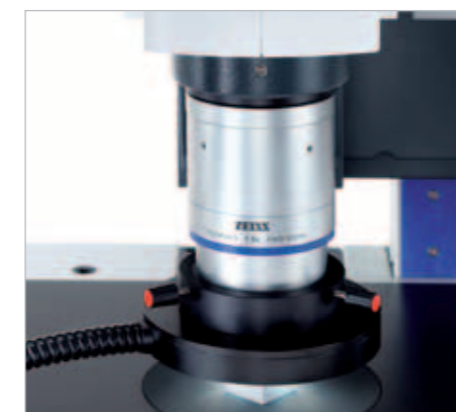

- Slit-ring illuminator incident-light darkfield**
The light hits the specimen's surface at a highly flat angle from all sides. Only the light scattered by the specimen's structure reaches the objective. Extremely fine structures will shine in their natural colors on a dark background.
- Flexible light guide with an active area diameter of $d = 9\text{ mm}$

There are two different LED cold light sources available to you:

- Homogeneous white daylight with a color temperature of 6,200°K
- 50,000 h lifetime*
- LCD display
- Extremely quiet ventilation system
- Low energy consumption
- Stackable
- 3-pos. filter slide for conversion, halogen, and color filters

* With the light reduced to 70%



- Coaxial epi-illumination**
- For SteREO Discovery only
 - Ideal for flat, specular specimen
 - Optimum results with PlanApo S 1.0x objective
 - Lambda/4 cab S needed for vertical observation/ documentation

- CL 9000 LED**
- Luminous flux: 900 lm**
 - CAN module, can be controlled by SYCOP 3 and/or software

- CL 6000 LED (not pictured)**
- Luminous flux: 600 lm**

** Measured at the light guide exit with an active area diameter of 9 mm

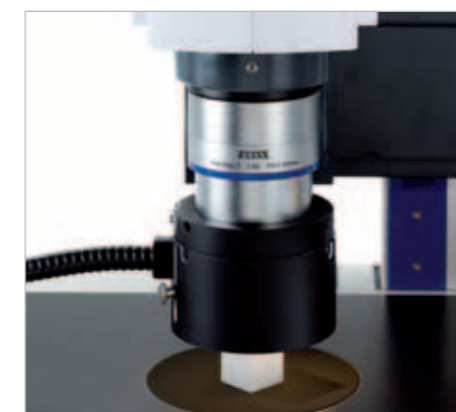

- Diffusor S, telescopic, $d = 66\text{ mm}$**
Indirect reflected-light illumination for contrasting specimens with shiny surfaces. Glare is avoided due to the soft light. Use gliding and/or ball-and-socket stages to better align your specimens.

- Slit-ring illuminator, $d = 66\text{ mm}$, for objective nosepiece with: 13 mm light-conducting rod 51 mm light-conducting rod**



Reflected Light with Direct LED's

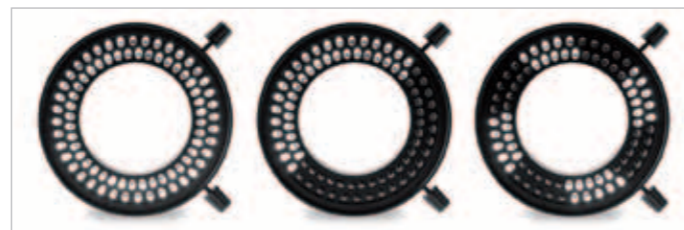

Full circle, semicircle, and up to four-eighths of a circle – switch and turn the light segments to adapt the illumination to your specific needs.

VisiLED gives you all the benefits of long-life neutral white LEDs: without infrared portion, excellent daylight quality, and the option of being controlled electronically.



- Reflected light brightfield illumination with:
- **VisiLED ring light S 80-55 BF** (not pictured) for objectives with a free working distance of 55 to 95 mm.
 - **VisiLED ring light S 80-25 BF** for objectives with a free working distance of 25 to 50 mm.

- All-side reflected light darkfield illumination with:
- **VisiLED ring light S 40-10 DF** (not pictured)
 - ALDF adapter for mounting the ring illuminator on the objective

VisiLED ring illuminators, holders, and spacer rings can be mounted directly on objectives with $d = 66$ mm.



To combine reflected light brightfield and darkfield illumination, use a special adapter to mount the **VisiLED ring light S 80-25 BF** on the bright-field ring illuminator.

The multi controller MC 1500 makes it easy to switch between the brightfield, darkfield and mixed light modes. The multicontroller can also store optimized illumination settings that can later be reproduced at the touch of a button.

The illuminators' adjustable light segmentation expands the options available to establish contrast in reflected-light applications.

Reflected Light with Direct LED's



Reflected light, brightfield, quarter circle

Reflected light darkfield, full circle

Mixed light, combination of brightfield and darkfield

While darkfield illumination brings out the raised contours of this 50-cent coin, mixed-light illumination reveals irregularities on the surface.

VisiLED ring illuminators can be controlled segment by segment, making it possible to produce shadows on the specimen surface that high contrast and more information.

VisiLED slim ring light S BF, $d = 66$ mm

- Comes with two focus rings for different working distances: Focus ring f50 for FWD of 40–90 mm
Focus ring f25 for FWD of 20–40 mm
- Optional: Darkfield for VisiLED slim ring light: ring mirror f10 for FWD of 5 to 10 mm

The slim design of SLIM ring lights makes it possible to retrofit them on all the objectives in a turret.



There are two different control units available for VisiLED ring illuminators:



Multi controller MC 1500

- Can control one or two ring illuminators
- Brightness control with indicator
- Segment control and rotation
- Can store up to four illumination settings
- Strobe mode and trigger-based operation
- Thermo controller
- RS-232 interface
- Optional foot switch

Multi controller MC 1000

- Can control one single VisiLED ring illuminator
- Adjusting knob for segment control
- Adjusting knob for rotation
- Adjusting knob for light intensity setting



Transmitted Light Illumination

Transmitted light microscopy makes the structures and details in transparent and semitransparent objects visible.



All of the controls on the transillumination base 300 are ergonomically laid out so that your hands can rest – relaxed – on your desk or table.

Transillumination base 300

This rigid, space-saving, flat transmitted light unit enables quick switching between brightfield, darkfield and oblique illumination.

- Manual quick-switching mechanism to change between different illumination and contrast methods
- Mechanical slider for adjusting the light stop in oblique illumination (RC) or for producing a one-sided darkfield
- If the light stop is completely inserted, a black background will be produced, e.g. for fluorescence applications
- Adjusting knob for light intensity setting
- Glass insert plate $d = 120$ mm, insert $d = 28$ mm, and antiglare shield
- Foot print: 320×370 mm ($h = 42$ mm)
- Foot bottom S (optional)
- Can be used with: Focus Motor 3 with central profile column 490 mm; coarse/fine drive with profile column 490 mm; Coarse/fine drive with T-column 350 mm

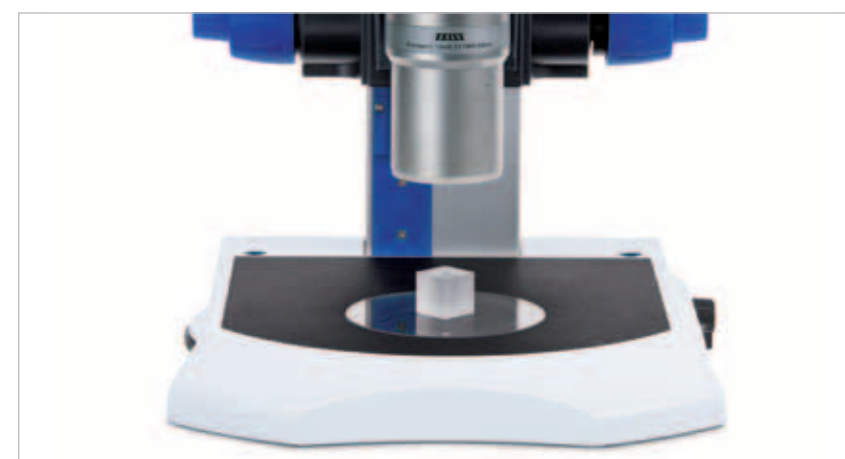

BF detent position: **Brightfield**

The light opening is completely open. Homogeneous illumination, even on large areas.



Brightfield

For transparent, high-contrast, and dyed specimens; to display contours and profiles in front of a bright background.

Young mouse, lengthwise
PlanApo Z 0.5x/0.125 objective
Magnification: 6x *

RC detent position: **Relief contrast**

When the corresponding slider is used to position a light stop horizontally in front of the luminous field, the oblique transmitted light that results will produce a relief effect on the specimen. In addition, a one-sided dark field can be produced.



Relief contrast with oblique illumination

Even faint structures in transparent objects will appear in the form of reliefs in front of a bright background. Particularly well-suited to undyed samples.

Sea urchin embryo
PlanApo S 1.0x objective
Magnification: 40x *

DF detent position: **Darkfield**

An annular diaphragm for all-sided darkfield illumination is placed in the beam path. One-sided shadowing can be produced by inserting the stop for oblique transmitted light illumination.



All-sided darkfield

Fine structures will shine in their natural colors in against dark background.

Squid embryo
PlanApo S 1.0x objective
Magnification: 25x *

* Total magnification with 10x eyepieces

Illumination

Transmitted Light Illumination

A continuously variable mirror adjustment mechanism with multiple degrees of freedom allows you to adjust the illumination beams' angle of incidence. In this way, you can establish the ideal illumination needed to contrast different kinds of specimens.



Three sliders allow you to change the position of the mirror relative to your specimen.

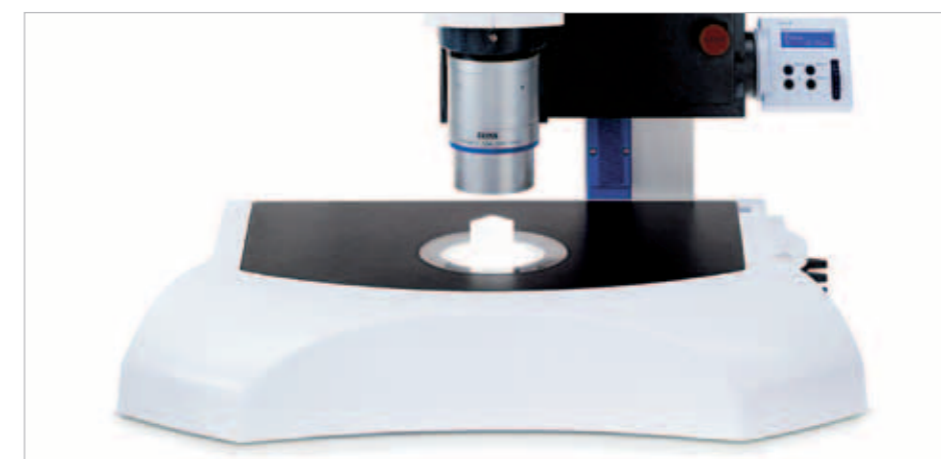

Transmitted light equipment 5

Use the module that can be retrofitted to the stand base 450 for examinations in brightfield, one-sided darkfield, or oblique transmitted light illumination configurations. The large, sturdy working stage provides plenty of room in the specimen area and makes work such as screening petri dishes and other culture dishes easier.

- Foot print: 450×300 mm
- Working stage: 410×250 mm
- Glass insert plate: $d = 120$ mm
- Maximum illuminated field of view: 50 mm
- Cold light source: ZEISS CL 1500 ECO, CL 6000 LED, or CL 9000 LED CAN

Powerful and effective:

ZEISS CL 1500 ECO cold light source:

- High luminous flux, continuous control
- 15 V/150 W halogen lamp
- Flicker free light for stable live images on screen
- Quiet ventilation system

Matching accessories:

- Flexible light guides with an active area diameter of $d = 4.5$ mm
- Two-arm gooseneck light guide with an active area diameter of $d = 4.5$ mm
- All other light guides with an active area diameter of $d = 9$ mm

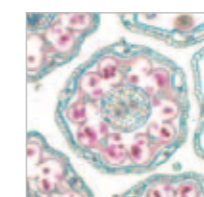

Brightfield

for transparent, high-contrast and dyed specimens and to display contours and profiles

Daisy
PlanApo S 1.5x objective
Magnification: 150x *

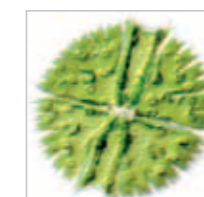

Oblique illumination

brings out low-contrast structures in transparent and opaque specimens

Micrasterias green alga
PlanApo S 1.5x objective
Magnification: 150x *

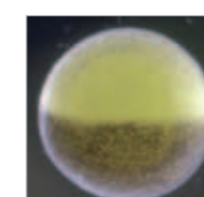

One-sided dark field

Fine, low-contrast structures shine brightly in their natural colors in front of a dark background.

Frog embryo
PlanApo S 1.5x objective
Magnification: 150x *



Transmitted Light Illumination

Fast, reliable, and reproducible brightfield, darkfield or oblique illumination. Easy-to-use button controls allow you to position modulators and best illumination depending on the optical configuration of the system.



Transmitted light at the touch of a button – two scroll wheels make it easy to adjust illumination brightness, contrast, and homogeneity as needed.

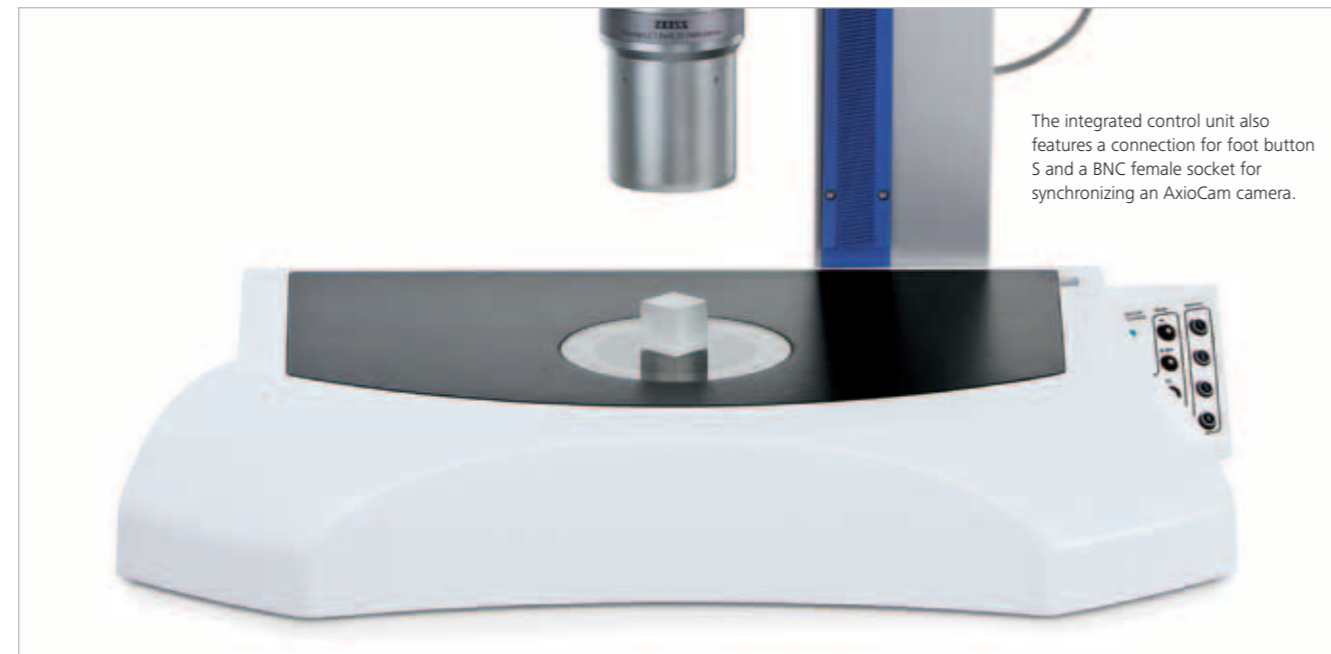

The integrated control unit also features a connection for foot button S and a BNC female socket for synchronizing an AxioCam camera.

Transillumination top 450 mot

- Motorized transmitted light unit; can be retrofitted on stand base 450
- Flicker free LED white light (similar to daylight)
- For brightfield, brightfield plus, darkfield and oblique illumination
- Independent brightness, homogeneity, and contrast adjustments
- Best Mode button and up to four stored configurations
- Foot print: 450 x 300 mm
- Rugged working stage: 410 x 250 mm
- Glass insert plate with d = 120 mm

In *Best Mode*, the system will automatically pick the illumination configuration based on its zoom position, providing you with optimized levels of contrast, homogeneity, and brightness.



Transmitted Light Illumination

Transmitted light in seconds: place your specimen, bring it into focus, and press *Best Mode*. The system will automatically set the best illumination configuration for your zoom setting, choosing the options that provide the best contrast and homogeneity.



All of the functions provided by the Transillumination top 450 mot are clearly laid out in SYCOP 3 and are intuitive and easy to use.



Use SYCOP 3 to store your entire device's configuration, including its transmitted light settings; then reproduce it as needed by simply pressing a button.

The stage's height means that the specimen is farther away from the transmitted light illuminator. The Transillumination top 450 mot will detect the presence of a stage. The modulators will then be moved in such a way that the image quality will be virtually retained.

Zooming:

- from overview (field of view: 14 mm; magnification: 16x) (Fig. left)
- into detail (field of view: 2 mm; magnification: 112x) (Fig. right)



Drosophila embryos
Axio Zoom.V16, PlanApo Z 1.0x objective
Transillumination top 450 mot, *Best Mode*

Microsampling

Microsampling allows you to quickly and safely manipulate microscopic objects. With the semiautomatic **aureka®** platform, you can deal with different kinds of structures, all the way down to individual cells.



The **6X stage top holder** and the **6X 237 x 157 mm slide tube insert** can be used to isolate sperm from a mixture of cells and transfer them to tubes.

- SteREO Discovery.V20 with **aureka®** microsampling platform consisting of:
- 6X control unit
 - 6X CAN box
 - 6-axis (6X) base unit can be retrofitted; with modified bracket for Focus Motor 3
 - Quick-change Click 'n' Sample tool modules with magnetic holder
 - Multifunctional control unit
 - CAN connection to microscope (status signals are exchanged between the microscope and **aureka®** to ensure collision-free work)

- 450 heater** (230 V)
- 450 heatable ferromagnetic insert
 - Heatable glass stage with d = 120 mm

- 450 ferromagnetic insert** (not pictured)



Click 'n' Sample – easy-to-change modules:

- **6X capillary module (1)** for injecting, extracting, and transplanting
- **6X standard microgripper module (2a)** for breaking off particles
- **6X µdip microgripper module (2b)** for adhering with microspheres
- **6X µcut microgripper module (2c)** for grabbing and cutting

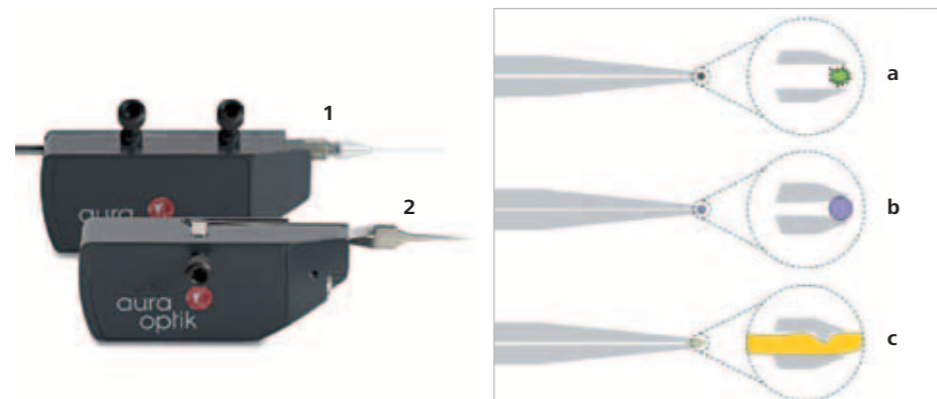

Microsampling

The control unit makes moving the **aureka®** system and using its functions completely intuitive. Holding, cutting, grabbing, isolating, and injecting – you can move the tool unerringly in up to six different degrees of freedom with a single hand.

- Multifunctional control unit for **aureka®** microsampling platform
- 3D joystick with six degrees of freedom (6X) for manipulator and tool functions
 - Single-hand operation
 - Up to six positions can be stored
 - Display for setting up custom parameter configurations (e.g. movement sensitivity) with the menu-based interface



The large space between the objective and the stage can be used to handle all types of specimens. You can even isolate trichomes from tobacco plants if need be!

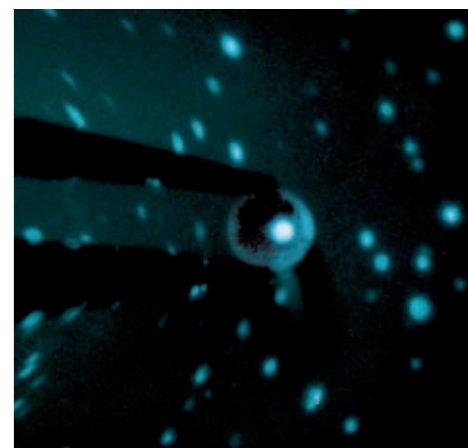
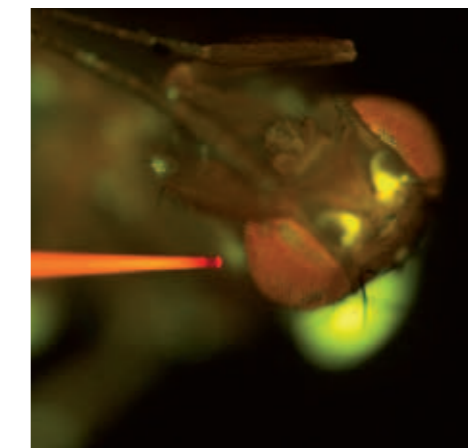
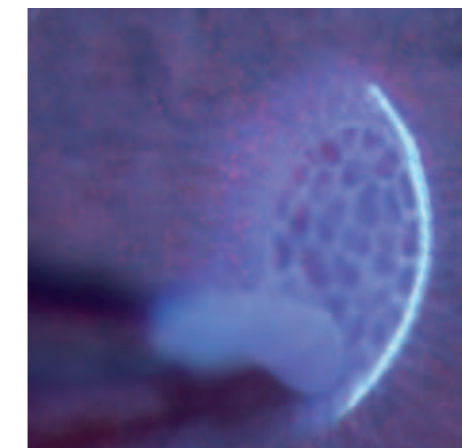

Tool modules in action:

Microtweezers

The molecular analysis of special digestive glands, such as the ones in this tropical pitcher plant, can provide information on how specific metabolisms work. For this purpose the corresponding tissue must be fresh and intact. A microgripper is used to break off the glands from their environment, undamaged, and transfer them to a chemical analysis process.

Microcapillary pipettes

In order to survive, fruit flies require highly specialized perceptive faculties, which they have developed despite the fact that they have far fewer neurons than mammals. Only a few neurons are responsible for a specific task which means they can be accurately pinpointed. In order to label neurons that are connected to each other, microcapillary pipettes are used to inject fluorescent dyes into flies' brains.

Microspheres

Cancer cells have unique individual genomes. To be able to analyze their gene expression and assess their aggressiveness, they need to be examined individually. To obtain meaningful RNA samples, simply isolate living cells. With the help of microspheres, individual marked cells will be gently adhered in a suspension.

HIP

HIP (Human Interface Panel) has taken the place of traditional controls in the electronically operated stereo and zoom microscopes as well as in the Focus Motor system.



The Focus Motor moves slowly when the wheel travels small distances and faster when it travels greater distances.



HIP for focusing

- Scroll wheel for coarse and fine focus
- Offers three different speed profiles
- Shows the current Z-axis position
- Two memory buttons for storing Z-axis positions



Parameters such as the focusing speed, display contrast, and acoustic signal can be adjusted in configuration mode.

Quickly pressing the **Mode** button in default mode will set the Focus Motor's position to zero, making it easy to perform Z-axis measurements.



In addition to the field of view diameter (Field), the maximum resolution (Resol) or the depth of field (Depth) can also be shown optionally by pressing the **Mode** button in default mode.

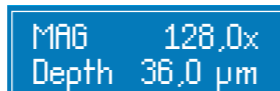

HIP for zooming

- Scroll wheel for zooming
- Offers three different zoom speed profiles
- Shows the current total magnification and additional optical parameters
- Two memory buttons for storing zoom values



In configuration mode, objectives, eyepieces, and other optical components are configured and the zoom speed is selected.



The backlight (75% on the screenshot to the left) and acoustic signal can also be configured.

MaRC

MaRC (Manual Rotary Control) keeps your focusing adjustments in familiar territory by relying on the traditional rotary knob.



MaRC makes it easy to keep things in focus, whether you are left-handed or right-handed.



Manual Rotary Control (MaRC)

Located at the **table-top based** to control Focus Motor units.

Features the following functions:

- Coaxial coarse/fine focus
- Setting for direction of rotation (for left-hand or right-hand control)
- High-speed raising
- Memory button for Z-axis position
- Push buttons for zooming (SteREO Discovery.V12, SteREO Discovery.V20, Axio Zoom.V16 only)
- Click stops
- Table-top base
- CAN interface
- Indicator LED



MaRC on electronic zoom bodies



MaRC on Focus Motor

SYCOP 3

With SYCOP 3 - third generation of the System Control Panel - you are using a compact, modern and handy control unit for convenient and save operation of complex stereo and zoom microscope systems. Patented by ZEISS.



SYCOP 3 brings together a joystick, scroll wheels, buttons, and a touchscreen into a handy, mobile control unit.

- EMS 3 electronic module for connecting:
- SYCOP 3
 - Focus Motor
 - Up to 5 CAN components (RJ45)
 - Up to 2 CAN components (HD15)
 - Up to 2 foot buttons

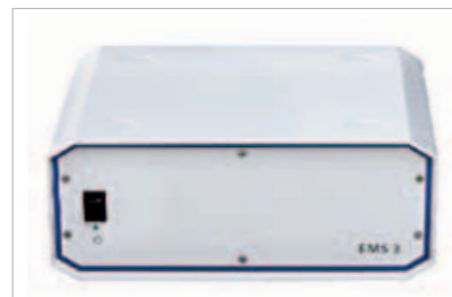

SYCOP 3

Just as with your computer mouse, you only need a single hand to quickly, reliably, and intuitively control all the important functions in your microscope when using SYCOP 3. Consequently, you do not have to look away from your specimen at any time.



The joystick is used for zooming and focusing. A click is all it takes to switch to controlling the motorized stage and move the specimen in the X-axis or Y-axis direction.



The two scroll wheels are used for fine focus adjustments. A click is all it takes to switch to the fine X-axis and Y-axis controls for the motorized stage.



The buttons are used to switch or trigger individually selected microscope functions such as illumination and fluorescence filter changes.



The display is used to control other functions and obtain information regarding the device's status.



SYCOP 3

Thanks to the CAN bus system, you can program various microscope settings and map them to a single button – enabling you to restore them quickly, easily, and reliably.



A large number of additional functions, device settings, and processes can be run or configured by simply pressing the necessary buttons.

Home
The home page provides you with access to all menus and tabs and is where you shut down the system.



The home page shows the following control and information fields:

- Navigation bar for the individual main menus: **Favorites, Microscope, Setup, User, and Display** (on the left side of the display)
- Button for shutting down the system and status summary** with current total magnification, visible field of view diameter on the eyepieces, resolution, and depth of field (on the right side of the display)
- Lens configuration (**Objective and Eyepiece**) and Z-axis position of focusing drive with the option of setting it to a value of zero (on the upper side of the display)
- The assigned configuration for the **joystick and scroll wheels** or for the six push buttons (on the lower part of the display)
- Control panel for up to three different **light sources**, indicating the intended use (on the central part of the display)

Work with click stops – reproducible magnifications at the touch of a button
Home\Microscope\Function\Click Stop



Depending on the microscope's optical configuration (objective, eyepiece), total magnification values are shown over the zoom range in appropriate increments. These magnification values can be used by simply pressing the corresponding button (the status window will remain on the display). If necessary, you can also access a detailed status report by pressing the Status button.

Work with Axio Zoom.V16 and the Fluor Z mot illuminator
Home\Microscope\Fluorescence\Fluor



The user interface shows the reflector modules that are currently in the reflector turret's four positions, as well as the active fluorescence filter module. Fluorescence illumination can be turned on and off with a button, and you can also switch between and activate different fluorescence configurations using the buttons (the status window will remain on the display).

Sample menus: SYCOP 3 with SteREO Discovery.V12, SteREO Discovery.V20, and Axio Zoom.V16.

SYCOP 3

SYCOP 3 continuously delivers information regarding the system's optical and mechanical state. This ensures that you will always know the magnification, visible field of view size, depth of field, and resolution with which you are working.



The EMS 3 electronic module makes it possible to connect up to two foot buttons in addition to SYCOP 3 and a PC, giving you another convenient option for controlling important microscope functions such as zooming and focusing.

Store and back up specific device setting configurations
Home\Microscope\Memory\Hardware Settings.



Store up to ten user-specific device configurations and restore them at the touch of a button. Each button can be edited individually.

Individually map selected microscope functions to the push buttons
Home\Setup\Key Settings\Buttons.



Map various functions to the three push button pairs. The lower bar on the display will show the corresponding functions. The same applies to the foot controllers; to access the corresponding page, open the **Foot Switches** tab.

SYCOP 3 will automatically monitor specific processes and functions as necessary.



For example: Using certain functions may require the microscope to move downwards (in the direction of the specimen) a certain distance while focusing. When this is the case, a prompt will appear asking whether you want to proceed with the movement, making it possible to avoid collisions with objects and specimens.

Sample menus: SYCOP 3 with SteREO Discovery.V12, SteREO Discovery.V20, and Axio Zoom.V16.

Image Documentation

Whether conducting research or performing routine tasks in the biological, medical, or industrial fields, you will always need a way to quickly and reliably document microscopic images.



The **drawing intermediate tube S** allows you to make flawlessly accurate drawings of microscopic objects and structures (see page 9 also).



SteREO Discovery V8 with a **Canon EOS 1000D** on the **intermediate photo tube S, left 100/100**

A series of adapters for the 60N connection point on the microscopes makes it possible to adapt:

- AxioCam digital microscope cameras
- Video cameras
- Compact digital cameras
- Analog and digital SLR cameras



Camera tube Z, 5 MP

- Tube with integrated 5 MP CCD camera for eyepiece-less microscopy
- Compatible with Axio Zoom.V16



Image Documentation

The AxioCam digital microscope camera enables you to efficiently handle your tasks at laboratories and research institutes.

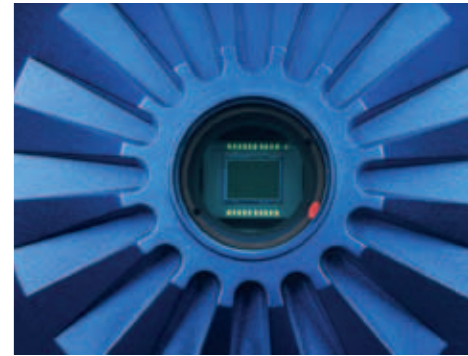

One of the AxioCam camera's features: an encapsulated sensor with a C-mount adapter.

AxioCam ERc 5s
Documentation made easy

Provides the flexibility you expect. This camera can be controlled with software or used independently of your computer. It stores images directly on SD cards.



AxioCam IC
Compact entry-level cameras for laboratories and routine tasks.



AxioCam MR
Versatile mid-range cameras for research and routine tasks related to life sciences and materials engineering.

AxioCam HR
Versatile high-end cameras for research and routine tasks related to life sciences and materials engineering.



Designation	AxioCam ERc 5s	AxioCam ICc 1	AxioCam ICc 5	AxioCam MRc	AxioCam MRc 5	AxioCam HRc	AxioCam ICm1	AxioCam MRm	AxioCam HRm
Sensor type	CMOS	CCD	CCD	CCD	CCD	CCD	CCD	CCD	CCD
Color/Mono	Color	Color	Color	Color	Color	Color	Mono	Mono	Mono
Resolution	5 megapixels	1.4 megapixels	5 megapixels	1.4 megapixels	5 megapixels	1.4 megapixels	1.4 megapixels	1.4 megapixels	1.4 megapixels
Pixels	2560 × 1920	1388 × 1038	2080 × 1038	1388 × 1040	2584 × 1936	Up to 4164 × 3120	1388 × 1038	1388 × 1040	1388 × 1040
Pixel size	2.2 µm	4.65 µm	3.45 µm	6.45 µm	3.4 µm	6.45 µm Resolution increase with microscanning	4.65 µm	6.45 µm	6.45 µm Resolution increase with microscanning
Cooling system				Peltier cooler	Peltier cooler	Peltier cooler		Peltier cooler	Peltier cooler
Dynamic range				1:2200	1:1200	1:2500		1:220	1:250
Sensor size	1/1.25"	1/2"	1/1.8"	2/3"	2/3"	2/3"	1/2"	2/3"	2/3"
Diagonal	7.1mm	7.9mm	8.9mm	11.1mm	10.9mm	11.1mm	7.9mm	11.1mm	11.1mm
Maximum frame rate	13 images/sec (at 800 × 600)	17 images/sec	9 images/sec	Up to 33 images/sec (at 276 × 208)	Up to 13 images/sec (at 430 × 322)	Up to 30 images/sec (at 430 × 322)	15 images/sec	Up to 30 images/sec (at 430 × 322)	Up to 30 images/sec (at 430 × 322)
Port	USB2	FireWire b	FireWire b	FireWire a	FireWire a	FireWire a	FireWire b	FireWire a	FireWire a

For additional cameras, visit: www.zeiss.com/axiocam

Imaging

ZEN imaging software transforms your microscopes and cameras into powerful imaging systems.

The software is designed to let you manage your entire image acquisition, processing, and analysis workflow interactively.



Smart Setup recommends the ideal dye and wavelength combination for your fluorescence experiments.

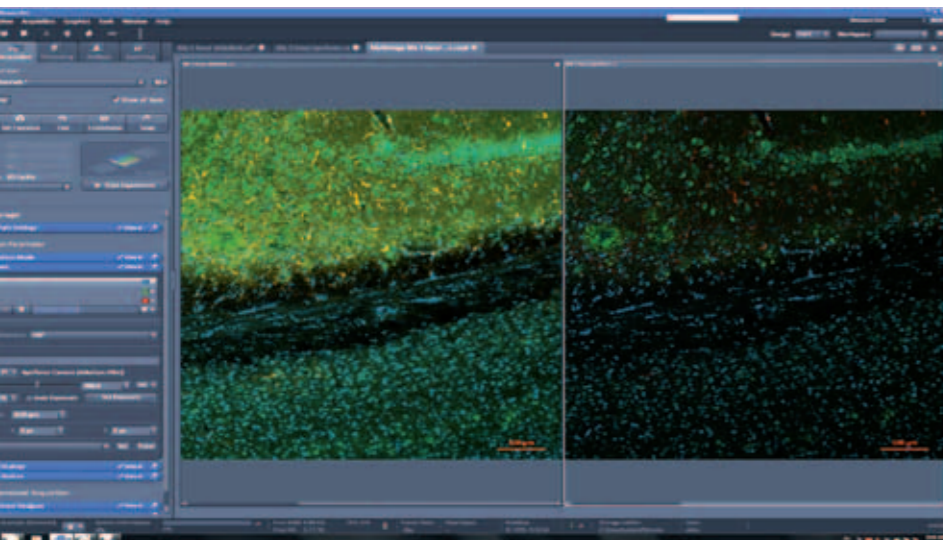

Multichannel ZEN module

Use this module to capture images in multiple fluorescent channels: simply select your dyes from a fully integrated database containing the spectra of more than 500 fluorophores. A channel with the ideal exposure time will be recorded for each fluorescence excitation, with the possibility of assigning an independent exposure time and microscope configuration to each channel.

Z stack ZEN module

Use this module to capture axial image stacks. ZEN will control your stand's focus motor, moving it stepwise with the necessary increments while synchronizing it with the image-capture process. The optimum increments can be defined in a fully automatic manner or can be customized as necessary.

Extended focus ZEN module

Use this module to generate images with an expanded depth of field by using the Z-axis image stacks that you have already obtained. This will enable you to extract sharp details from different focus positions from your existing images and merge them into a new image.

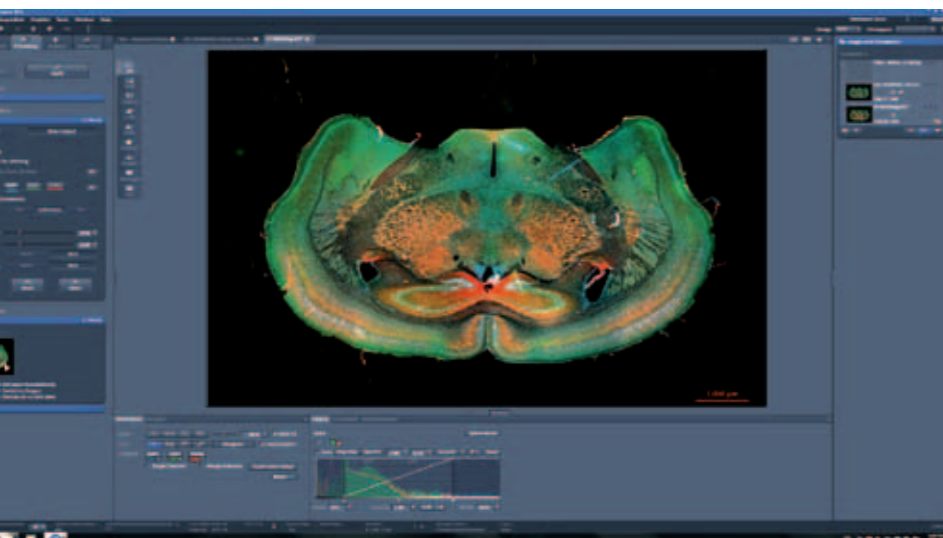

Tiles and positions ZEN module

Use this module to analyze large areas by automatically scanning specimens together with a motorized stage. The module will then use the various individual images to generate an overview image that you can navigate and zoom into just like a map. The module ensures that the individual images will be perfectly aligned, establishing an ideal basis for further analysis.

*Specimen: Brain section of a mouse embryo
(diameter approx. 12 mm, 40 μ m thick)
Three fluorescent labels*

Imaging

ZEN allows you to save image data – complete with hardware and software settings – in the CZI image file format. You can also use metadata to reproduce image capture conditions and experiments, and document your data as it develops.

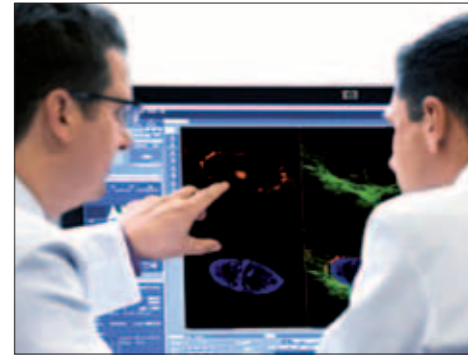

Important workflow controls are brought into the foreground, while less-frequently used buttons remain in the background (and can be activated with a click as needed).

Time lapse ZEN module

Use image sequences to document dynamic processes in your specimens. ZEN will control your microscope's illuminator to an accuracy of milliseconds, preventing unnecessary photobleaching – an important requirement for quantitative analyses of processes in living specimens. You can export your recorded images for presentations and publications in conventional video formats at any time.

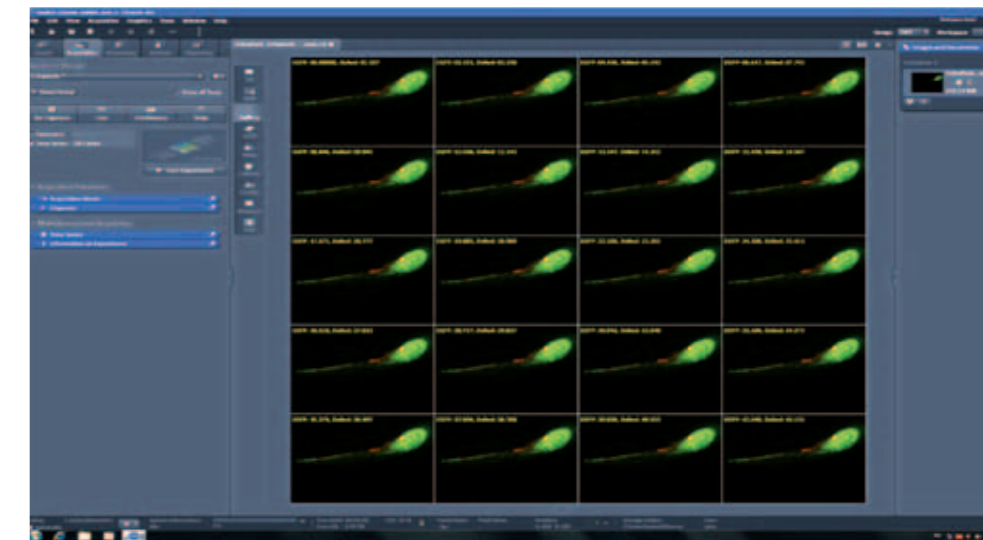

ApoTome.2

When fluorescent-labeled specimens are shown in 3D, structures outside the depth of field are shown out of focus. This, in turn, results in a lower signal-to-noise ratio for image data.

ApoTome.2 solves this problem by using structured illumination. Contrast and resolution increase even when imaging entire model organisms – easily, quickly, and cost-effectively.

For further information and additional modules, visit: www.zeiss.com/zen

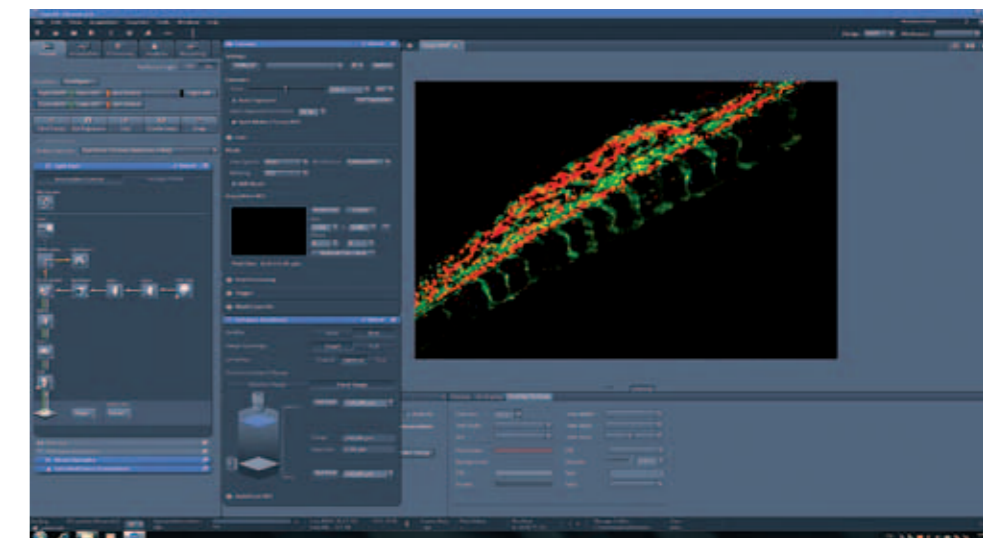

Imaging

AxioVision is your software of choice for digital microscope systems in the industrial and materials engineering sectors. Its modular design offers you attractive options to tailor the system to your needs.

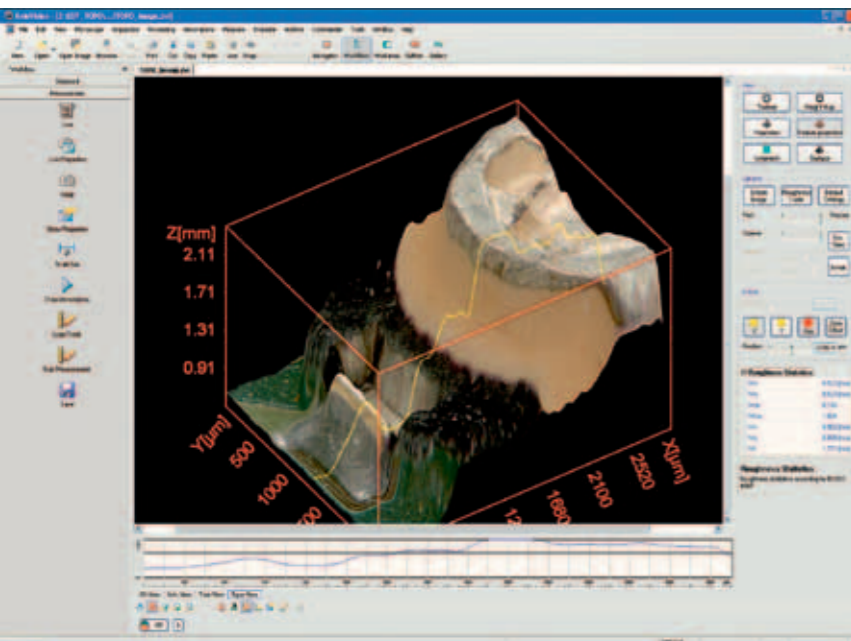
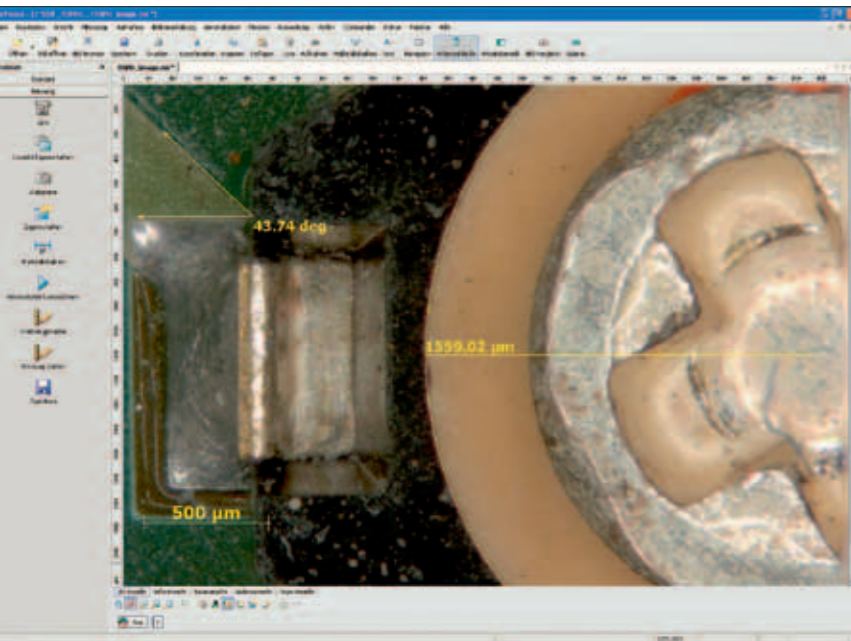

Extended focus module
This module allows you to acquire images from various focal planes and merge them into a single image with an expanded depth of field.

Interactive measurement module
Use this module to measure geometrical parameters of individual objects and structures on your sample.

Topography module
Use this module to generate relief maps based on Z-axis image stacks and view these maps in 3D. Other display formats are also available:

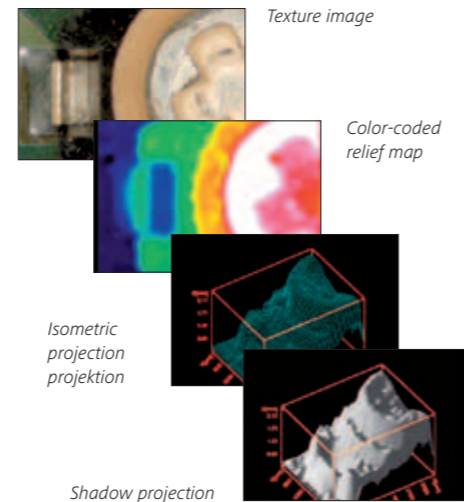

Imaging

With AxioVision you combine the integrated microscope control with a professional software solution for image acquisition and analysis, documentation and data archiving.

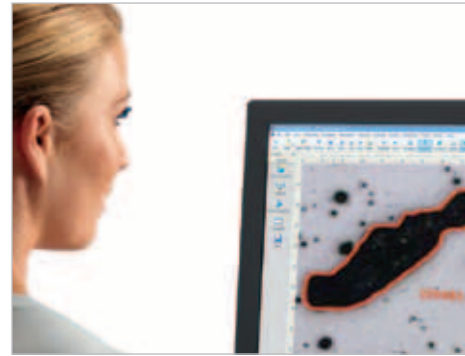

AxioVision allows you to control all motorized components automatically or interactively. You can store microscope setting configurations and retrieve them when needed.

MosaiX module
Use this module to analyze large material areas. Simply scan your specimen, acquire single images and generate a resulting overview image.

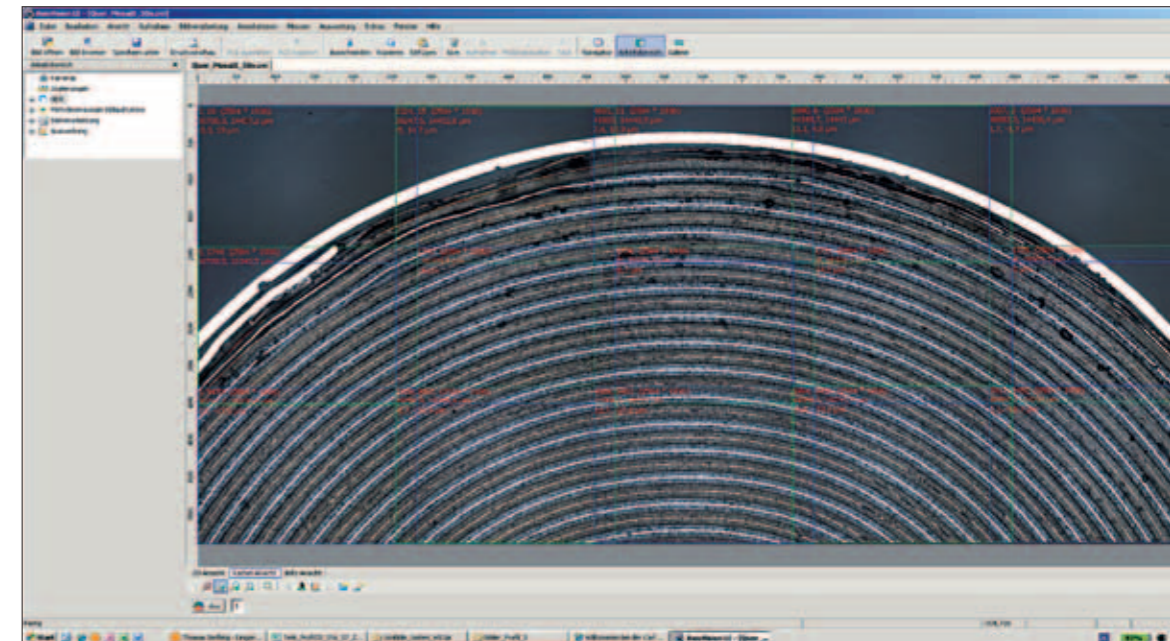

Particle Analyzer
Fully automatic turnkey system for measuring and classifying particles with a minimum size of 5 µm.

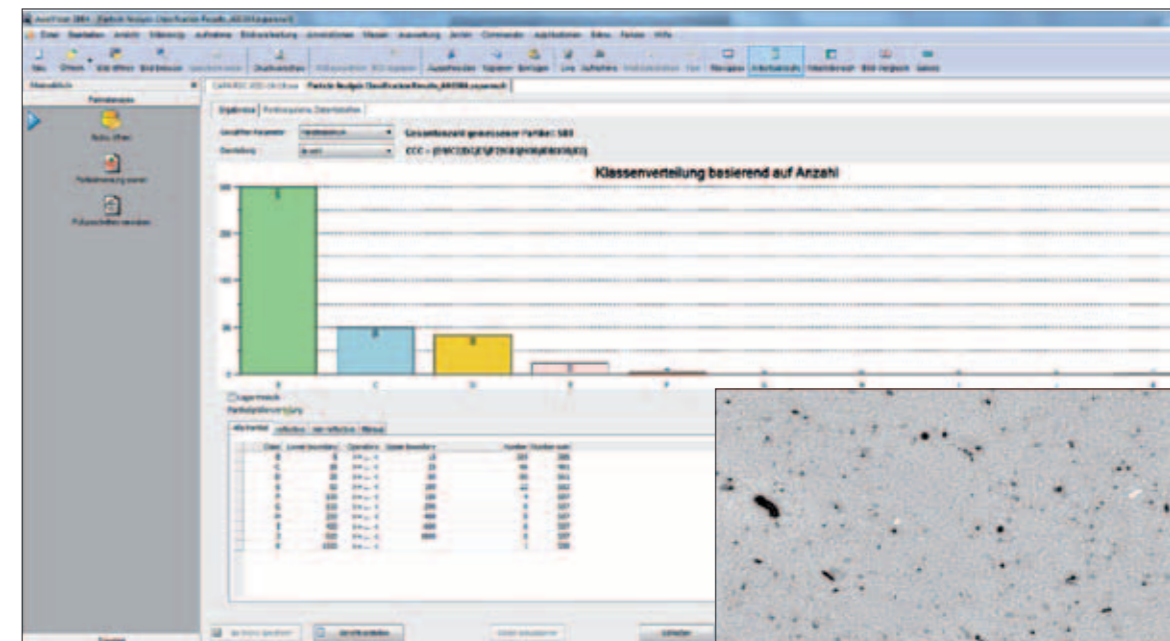

For further information and additional modules, visit: www.zeiss.com/axiovision

The Technological Factor

Better 3D images, higher resolutions, larger zoom ranges – on the technological frontier, conventional stereo microscopy has finally reached its outer limits. Every lens and every mechanical detail has certain tolerances, even when the highest-precision manufacturing methods are used. But as resolution and contrast become more important, the less acceptable these tolerances become.

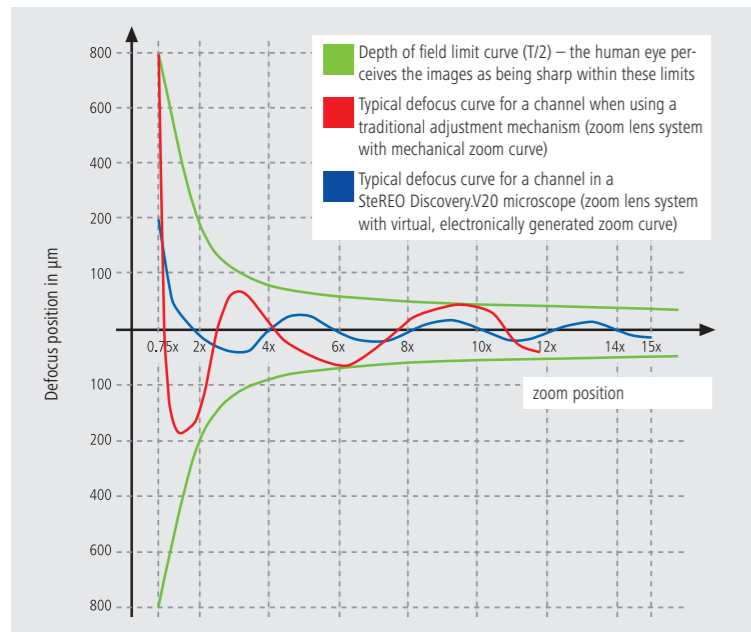

Conventional technology reaches its limits

The heart of a CMO stereo- or zoom microscope is its zoom lens system. When zooming, lenses move and must be brought to a specific position relative to other fixed lenses – all with the utmost precision. A mechanical curve – a metal part milled with extreme care – plays the principal role in ensuring the accuracy of these lenses' travel path and a microscope's resultant optical quality. To date, there has simply been no other way to achieve the required precision for even more powerful stereo- and zoom microscopes.

Diagram comparing the defocus curve of a conventional mechanical zoom lens system with that of a motorized system (SteREO Discovery.V20). The graph clearly shows that the motorized zoom lens system's deviations from the axis line are only half as big as those of the mechanical one. In terms of image quality this means that, together with its electronically controlled zoom lens system, the SteREO Discovery.V20 delivers images with twice the sharpness as its conventional counterparts.



Fast, flexible, effective: SteREO Discovery stereo microscopes undergoing final assembly at the Carl Zeiss Microscopy GmbH clean rooms in Jena. The method? One-piece continuous flow manufacturing based on value stream design criteria.

The solution:

a new operating method

Mechanical curves have been replaced with virtual ones in the SteREO Discovery.V12, SteREO Discovery.V20, and Axio Zoom.V16 microscope models. The moving lenses are moved by stepper motors, while a processor ensures that they are positioned with the utmost accuracy and precision, guaranteeing significantly sharper microscopic images throughout the entire zoom range. This is extremely beneficial when it comes to research applications.

Looking at 3D images on stereo microscopes is now much less strenuous

The stereoscopic images produced for both eyes are much sharper and match each other better, reducing the effort the brain has to make to see a 3D image.

Sharper images mean better contrast

This becomes crucial whenever microscopes are used at high magnification levels. Virtual curves enable observers to push their microscopes all the way to their magnification limits without having to sacrifice quality.

Greater magnification as the result of greater zoom ranges

While a zoom factor of 16 was previously considered to be the upper limit of what was possible, our new technology now allows for significantly greater zoom factors.

Indeed, electronically controlled ZEISS zoom lens systems are a milestone in stereo- and zoom microscopy.

Over 30 patent applications have secured this technological advantage for the long term.

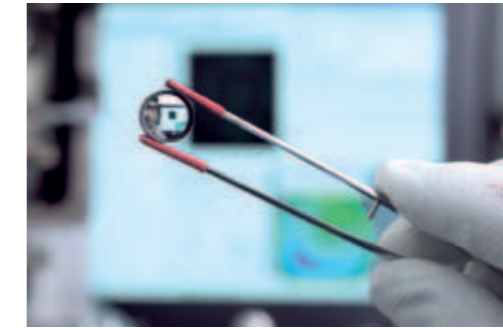

Before assembly begins, each lens is exactly calibrated against a reference "null lens set" and the values are saved in a data pool. This feeds the database used by a computer to select optimally matched lenses for the zoom system. By doing this, an optimally coordinated lens family is developed for every microscope.

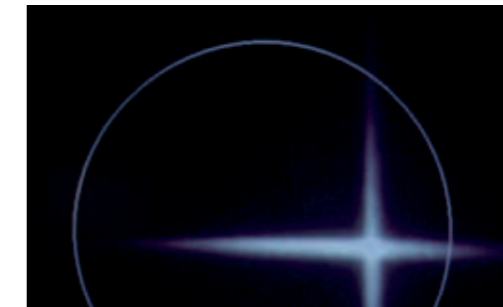

Rotating reflection from a lens. As soon as it is in the circular mounting area ...



... a moving micro clapper on the computer-controlled glue levelling robot performs the necessary fine adjustments independently.

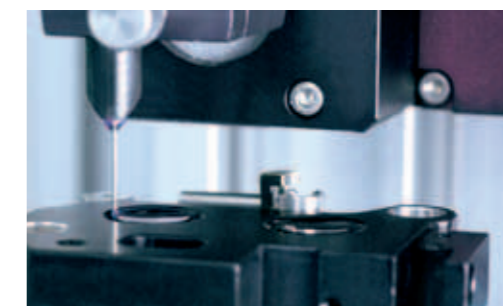

Once the lens has been pushed into position, it is fixed in place immediately. A 0.5 mm thick cannula is used by high-precision tools to automatically apply continuous adhesive beads with high accuracy and precision.

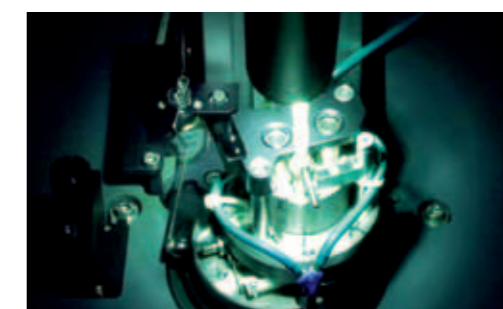

The adhesive beads are then cured under UV radiation.



The precise movement of all the moving optical elements in the optical train is programmed on the zoom lens system adjustment device. Around 7,000 support points are analyzed in a computer for this purpose. This ensures that each individual stereo microscope gets its own fine-tuning calibration and its own individual zoom curve.



Service and Support for Your ZEISS Microscope System

ZEISS Moments are about passion. The same passion that drives us to support and accompany you and your ZEISS microscope over its life cycle ensures that your work will lead systematically to success.

You Work Hard: We Make Sure Your Microscope Keeps Pace with You.

High imaging quality, reliable results and instrument availability are the parameters of your day-to-day working life. Your ZEISS microscope integrates seamlessly into this demanding workflow. It provides you with insights and results that you can trust; thorough, comprehensive and reproducible. With our Life Cycle Management we help you to keep your microscope in optimum condition to get these optimum results.

Life Cycle Management Comes with Your Microscope

Life Cycle Management from ZEISS backs up our solutions throughout the working life of your ZEISS microscope system. From the procurement phase onward, you can count on our support with site surveys to optimize the location for your microscope system. Throughout the operational phase we will complement our service with support for relocations and upgrade opportunities that enhance or expand your possibilities. As soon as you think about replacing your long-serving microscope with a new one, we will take care of the disassembly and disposal of systems that are no longer needed. Rely on our service features: our employees analyse the status of your system and solve problems via remote maintenance or directly at your location.

From Expert to Expert

Never hesitate to ask our application specialists to support your specific tasks. Take advantage of our training sessions for any colleagues or employees who will be working with your ZEISS microscope.

Peace of Mind and Availability with regular Maintenance

Your service agreement is tailor-made for you. Make sure you take advantage of all the opportunities your ZEISS microscope system offers. Get optimized performance, instrument reliability and availability at predictable costs. Choose from different service levels of our Protect service agreement, ranging from Protect preventive, via Protect advanced, to Protect premium. We look forward to discussing your ideal service agreement personally..





// DISCOVERY
MADE BY ZEISS

The moment you see something that you have never seen before.

This is the moment we work for.

How will doctors treat their patients in the future? What kind of role will pictures and videos play in tomorrow's communications? How much more can semiconductor structures be miniaturized? These and many other questions are what drive the people at ZEISS every day.

As a pioneer and one of the world's leading corporate Groups in the field of optical systems and optoelectronics, ZEISS has redefined the limits of imagination from the very beginning.

ZEISS Medical Technology continuously sets new global standards with its products and solutions. Doctors and patients can thus benefit from innovative technologies such as the INTRABEAM™ radiotherapy platform, which provides breast cancer patients with a significantly gentler and shorter course of treatment.

Whether it's the pin-sharp image on the movie screen showing *Lord of the Rings*, the most successful film trilogy of all time, or the accurate image that binoculars and spotting scopes provide to lovers of nature, ZEISS makes fascinating details visible.

When precision is in demand, ZEISS Industrial Metrology solutions guarantee strict quality standards. This makes airplanes safer, cars better, and wind turbines – the future of electrical power – more efficient.

Every second, two people in the world decide to get a pair of ZEISS eyeglass lenses. Relentless drive and far-sightedness are what enable Vision Care to develop innovative eyeglasses, such as MyoVision™, which reduces the worsening of myopia in children.

This unique passion for top performance is what holds all of our business units together, and it's how ZEISS creates customer value and inspires the world to see things it has never seen before.





Instruments

info@ctk-instruments.com

www.ctk-instruments.com

866-464-1005