



Product Information
Version 1.0

ZEISS Axio Vert.A1

Simply Get All Information from Your Cells



We make it visible.

All Contrasts. All Information. All Flexible.

- › **In Brief**
- › The Advantages
- › The Applications
- › The System
- › Technology and Details
- › Service

Choose from all standard contrasting techniques, including DIC, to investigate your cell cultures. Axio Vert.A1 produces brilliant images to answer your questions.

Axio Vert.A1 is the only system in its class with such a large range of features, compact enough in fact to sit directly beside your incubator. Look into the very essence of your research while keeping your cell culture in its own protected environment.



 [HeLa Cells 10x](#)

Simpler. More Intelligent. More Integrated.

- › In Brief
- › **The Advantages**
- › The Applications
- › The System
- › Technology and Details
- › Service

Using All Standard Contrast Techniques, It's in a Class of its Own

Brightfield, Phase contrast, PlasDIC, improved Hoffman Modulation Contrast (iHMC) and Fluorescence contrast – Axio Vert.A1's range reads like an index of contrast techniques.

Alone in its class, it also employs Differential Interference Contrast. With DIC you visualize even the finest structures in your cells. And the new IVF contrast system is particularly impressive in IVF labs: without modifying the stand, you can switch freely between iHMC, PlasDIC and DIC as you investigate your samples.

LED Excitation – Gentle on Your Living Samples

You are working with fluorescence-labeled cells or specify transfection rates? With Axio Vert.A1 your samples remain safe in gentle LED light.

This microscope brings you tomorrow's standard – today:

- LED excitation has no unwanted UV component, so you will see a significant increase in the survival rate of your cells.
- Profit from an extremely long life time of the light source.
- Homogeneous illumination saves you time and bother on adjustments.
- LED illumination immediately works with full intensity – there is no heating and cooling period required.

Ergonomic Design Makes Your Work Easier

Ease of use is built right into Axio Vert.A1: Whether you are sitting or standing, simply use intermediate pieces to work comfortably in an upright position. The ergo tube lets you tilt the eyepieces as much as you need. You can always view your samples easily. Thanks to ergonomic design of all operating parts, your routine tasks and workflows will be easier – especially when you're in a particular hurry.



Your Insight into the Technology Behind It

- › In Brief
- › The Advantages
- › **The Applications**
- › The System
- › Technology and Details
- › Service

The IVF Contrast System Unites iHMC, PlasDIC and DIC without Modification

The new IVF contrast system is particularly effective in IVF labs: switch at will between iHMC, PlasDIC and DIC without modifying the stand. Axio Vert.A1 unites all three contrast techniques in one condenser and gives you enough room for micromanipulation.

The Stable Transmitted Light Arm Provides Precision You Can Rely on

Adapt all standard micromanipulators to the stable transmitted light arm of your Axio Vert.A1. Your work will be free of vibration: you regulate your movements under the microscope with extreme precision.



Embryo: Nucleus with nucleoli visible in right cell, iHMC



ICSI: Oocyte with Zona pellucida, PlasDIC

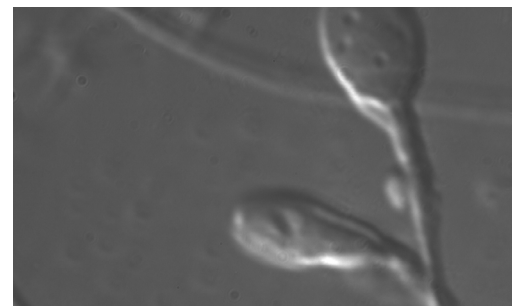

IMSI: Vacuoles in sperm cells, DIC

iHMC Reveals even Finest Structures in the Cell Nucleus

You examine embryos and assess cell nuclei? iHMC shows nucleus shape and nucleoli brilliantly.

PlasDIC Improves Your ICSI Results

Structures such as the Zona pellucida of oocytes are brought out particularly well by PlasDIC contrast technique. You can judge precisely where to inject, thanks to the strong and brilliant relief effect.

DIC Delivers Brilliant Images for IMSI

Top marks to DIC with IMSI for producing brilliant images at high magnifications. You can easily assess the shape and vacuole count of sperm cells.

ZEISS Axio Vert.A1 at Work

- › In Brief
- › The Advantages
- › **The Applications**
- › The System
- › Technology and Details
- › Service

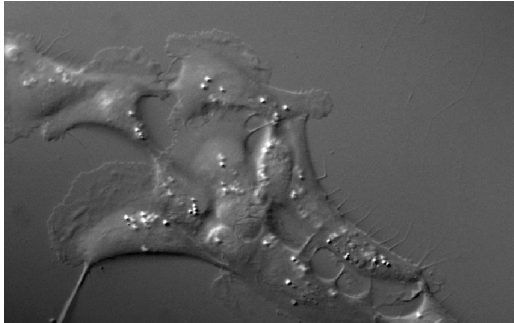

Keratinocytis of epidermis – DIC

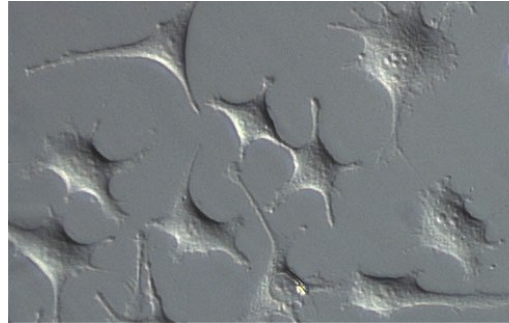

HeLa cells – PlasDIC

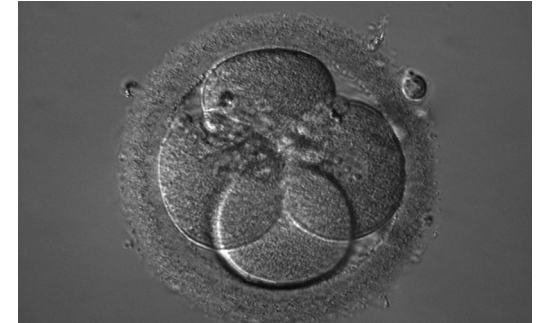

Embryo: Nucleus with nucleoli visible in right cell, iHMC



Click here to view this video on YouTube



HeLa cells – Phase contrast



ICSI: Oocyte with Zona pellucida, PlasDIC

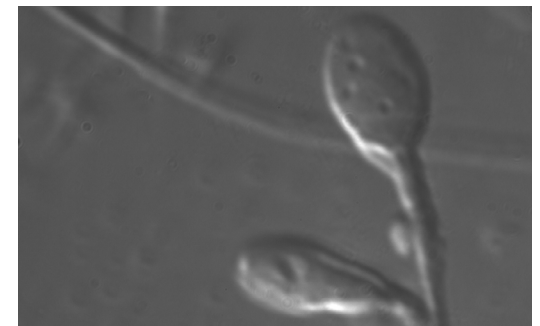

IMSI: Vacuoles in sperm cells, DIC

ZEISS Axio Vert.A1: Your Flexible Choice of Components.

- › In Brief
- › The Advantages
- › The Applications
- › **The System**
- › Technology and Details
- › Service



1 Microscope

- Axio Vert.A1, transmitted light
- Axio Vert.A1 FL, transmitted light and fluorescence
- Axio Vert.A1 FL-LED, transmitted light and LED fluorescence

2 Objectives

- A-Plan
- LD A-Plan
- LD Plan-NEOFLUAR

3 Illumination

- Transmitted light: halogen lamp, LED (wavelength 400 to 700 nm, peak at 460 nm)
- Reflected light: HBO 50, HBO 100, HXP 120 C, LED modules (wavelength, nm): 365, 385, 420, 445, 455, 470, 505, 530, 590, 615, 625 or neutral white: 540 – 580 nm

4 Cameras

Recommended cameras:

- AxioCam ERc 5s
- AxioCam ICc 1
- AxioCam ICm 1
- AxioCam MRc
- AxioCam MRm

5 Software

- ZEN lite
- ZEN pro

ZEISS Axio Vert.A1: System Overview

- In Brief
- The Advantages
- The Applications
- The System
- Technology and Details
- Service

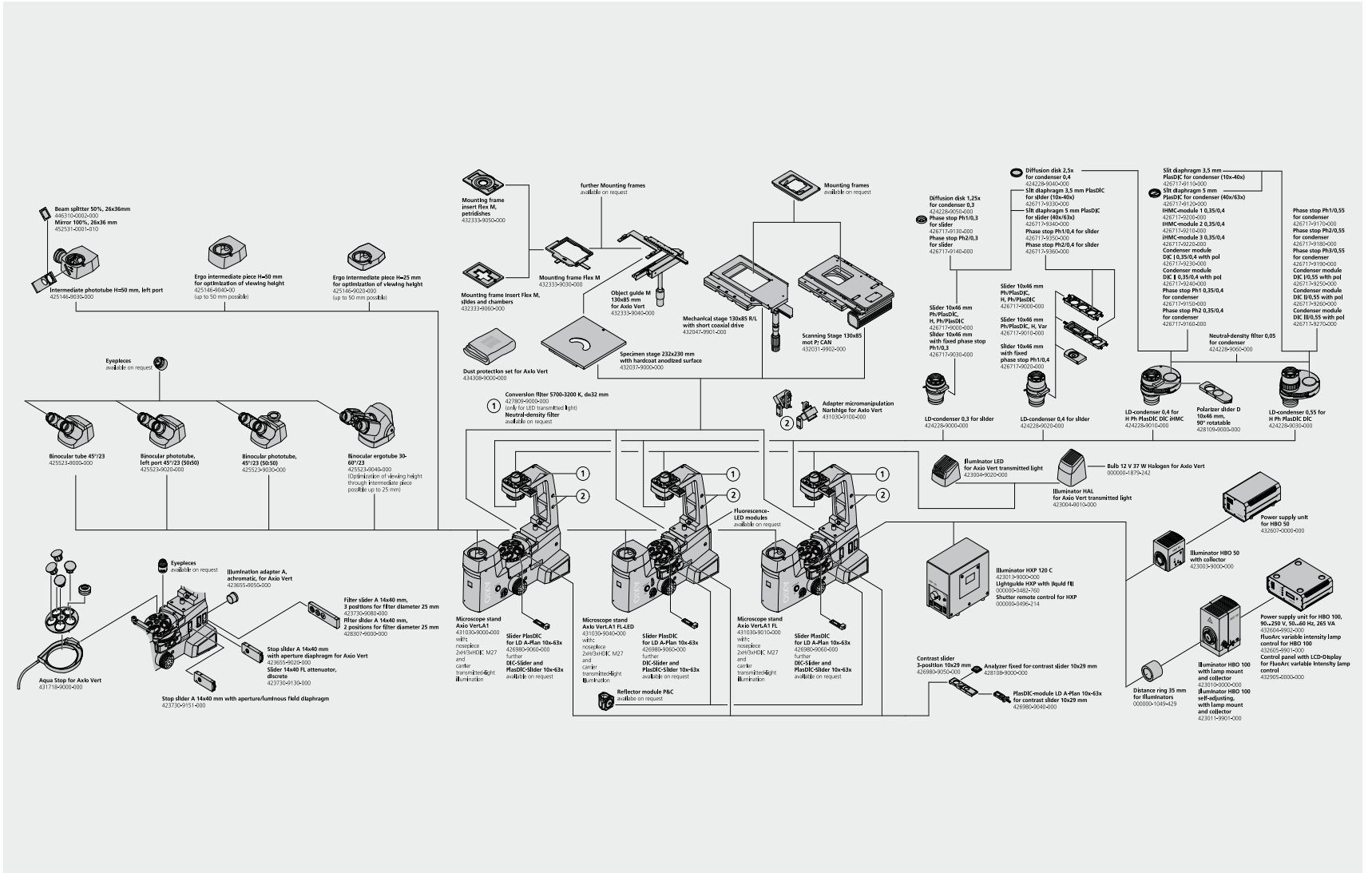

Technical Specifications

- › In Brief
- › The Advantages
- › The Applications
- › The System
- › **Technology and Details**
- › Service

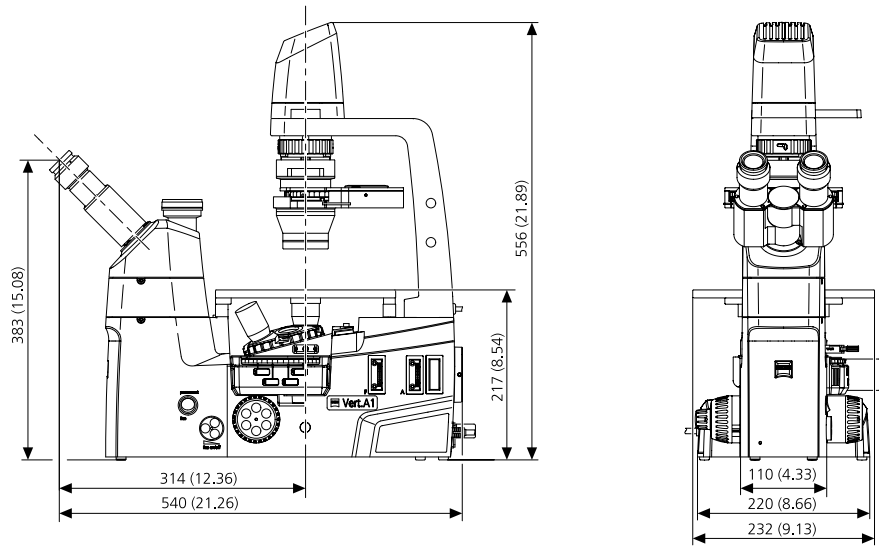

Microscope	ZEISS Axio Vert.A1	ZEISS Axio Vert.A1 FL	ZEISS Axio Vert.A1 FL-LED
Stand	manual inverted stand, transmitted light	manual inverted stand, transmitted light and fluorescence	manual inverted stand, transmitted light and LED fluorescence
Dimensions (W x D x H, including required space for cabling and plugs)	235 x 560 x 560 mm	235 x 560 x 560 mm	235 x 560 x 560 mm
Weight	10.5 kg	11.7 kg	12.3 kg
Eyepieces	Field number 23 (W-PI 10x/23 br foc), diameter: 30 mm		

Technical Specifications

- › In Brief
- › The Advantages
- › The Applications
- › The System
- › **Technology and Details**
- › Service

Objectives		ZEISS Axio Vert.A1	ZEISS Axio Vert.A1 FL	ZEISS Axio Vert.A1 FL-LED
Nosepiece turret	5x, H DIC M27 man. (2x H, 3x H DIC)	●	●	●
Objectives	A-Plan	○	○	○
	LD A-Plan	○	○	○
	LD Plan-NEOFLUAR	○	○	○
Objective magnification	1.25x – 100x	○	○	○
Contrast Methods (transmitted light)		ZEISS Axio Vert.A1	ZEISS Axio Vert.A1 FL	ZEISS Axio Vert.A1 FL-LED
Brightfield		●	●	●
Phase contrast		○	○	○
PlasDIC		○	○	○
iHMC		○	○	○
DIC		○	○	○
Illumination (transmitted light)		ZEISS Axio Vert.A1	ZEISS Axio Vert.A1 FL	ZEISS Axio Vert.A1 FL-LED
Hal 100 (Halogen)	Output: 37 W, controllability: continuous, ≤ 1,5 to 12V	○	○	○
LED	Output: 3 W, controllability: continuous, ≤ 1,5 to 12V	○	○	○
Fluorescence		ZEISS Axio Vert.A1	ZEISS Axio Vert.A1 FL	ZEISS Axio Vert.A1 FL-LED
HBO 50	Power consumption: max. 90 VA	–	○	–
HBO 100	Power consumption: max. 155 VA	–	○	–
HPX 120 C	Power consumption: max. 210 VA	–	○	–
4-position mount for LED modules	for reflected light fluorescence	–	–	●
4-position reflector turret	for reflected light fluorescence and DIC	–	●	●
<p>● included with stand ○ optional – not possible</p>				

Technical Specifications

- › In Brief
- › The Advantages
- › The Applications
- › The System
- › **Technology and Details**
- › Service

Accessories	ZEISS Axio Vert.A1	ZEISS Axio Vert.A1 FL	ZEISS Axio Vert.A1 FL-LED
Tubes			
Binocular tube 45°, 23	○	○	○
Binocular phototube, left 45°, 23 (50:50)	○	○	○
Binocular phototube, 45°, 23 (50:50)	○	○	○
Binocular ergotube, 30° – 60°, 23	○	○	○
Tubes, Ergo intermediate Pieces			
Intermediate phototube, H=50 mm, left port	○	○	○
Ergo intermediate piece, H=25 mm for optimization of viewing height	○	○	○
Ergo intermediate piece, H=50 mm for optimization of viewing height	○	○	○
Condensors			
LD-condensor 0,3 for slider	○	○	○
LD-condensor 0,4 for slider	○	○	○
LD-condensor 0,4 for H Ph PlasDIC DIC iHMC	○	○	○
LD-condensor 0,55 for H Ph PlasDIC DIC	○	○	○
Stages			
Specimen stage with optional object guide M for various mounting frames M	○	○	○
Mechanical stage 130x85 R/L with short coaxial drive for various mounting frames K	○	○	○
Gliding stage Z with stage inserts	○	○	○
Scanning Stage 130x85 mot P; CAN for various mounting frames K	○	○	○
Accessories			
Aquastop	○	○	○
Mounting frames, heatable mounting frames, incubators	○	○	○
Micromanipulation	○	○	○

- included with stand
- optional
- not possible

Technical Specifications

- › In Brief
- › The Advantages
- › The Applications
- › The System
- › **Technology and Details**
- › Service

Operational data

Area of Use	Closed spaces
Protection Class / Protection Type	I, IP 20
Electrical Safety	acc. to DIN EN 61010-1 (IEC 61010-1) allowing for CSA and UL specifications
Overvoltage Category	II
Radio interference Suppression	acc. to EN 55011 Class B
Interference Immunity	acc. to DIN EN 61326-1
Power Supply	100 to 240 V AC $\pm 10\%$
Power Frequency	50 to 60 Hz
Power Consumption internal Mains Adapte	max. 80 VA

Power Supply for HBO 100

Area of Use	Closed spaces
Protection Class / Protection Type	I, IP 20
Power Supply	100 VAC ... 240 VAC
Power Frequency	50/60 Hz
Power Consumption with HBO 100	155 VA

Power Supply for HBO 50

Area of Use	Closed spaces
Protection Class / Protection Type	I, IP 20
Power Supply	100 to 240 V AC $\pm 10\%$
Power Frequency	50 to 60 Hz
Power Consumption HBO 50	max. 90 VA

Power Supply for HXP 120 C

Power Supply	100 bis 240 V $\pm 10\%$
Power Consumption HXP 120 C	max. 210 VA

Technical Specifications

- › In Brief
- › The Advantages
- › The Applications
- › The System
- › **Technology and Details**
- › Service

ZEISS Axio Vert.A1 FL-LED

LED-illumination in reflected light with changeable LED modules, wavelengths	365, 385, 420, 445, 455, 470, 505, 530, 590, 615, 625 nm or neutral white (540 – 580 nm)
--	--

LED-classification	LED-risk group 1 acc. DIN EN 62471:2009
--------------------	---

ZEISS Axio Vert.A1 FL

Wave length	400 to 700 nm, peak at 460 nm
-------------	-------------------------------

LED-classification	LED-risk group 1 acc. DIN EN 62471:2009
--------------------	---

Fuses acc. to IEC 127

Stand Axio Vert.A1	T 3,15 A/H, 5x20 mm
--------------------	---------------------

Power Supply for HBO 50	T 1,6 A
-------------------------	---------

Power Supply for HBO 100	T 2,0 A/H, 5x20 mm
--------------------------	--------------------

Power Supply for HAL 100	T 5,0 A/H, 5x20 mm
--------------------------	--------------------

Count on Service in the True Sense of the Word

- › In Brief
- › The Advantages
- › The Applications
- › The System
- › Technology and Details
- › **Service**

Because the ZEISS microscope system is one of your most important tools, we make sure it is always ready to perform. What's more, we'll see to it that you are employing all the options that get the best from your microscope. You can choose from a range of service products, each delivered by highly qualified ZEISS specialists who will support you long beyond the purchase of your system. Our aim is to enable you to experience those special moments that inspire your work.

Repair. Maintain. Optimize.

Attain maximum uptime with your microscope. A ZEISS Protect Service Agreement lets you budget for operating costs, all the while reducing costly downtime and achieving the best results through the improved performance of your system. Choose from service agreements designed to give you a range of options and control levels. We'll work with you to select the service program that addresses your system needs and usage requirements, in line with your organization's standard practices.

Our service on-demand also brings you distinct advantages. ZEISS service staff will analyze issues at hand and resolve them – whether using remote maintenance software or working on site.

Enhance Your Microscope System.

Your ZEISS microscope system is designed for a variety of updates: open interfaces allow you to maintain a high technological level at all times. As a result you'll work more efficiently now, while extending the productive lifetime of your microscope as new update possibilities come on stream.

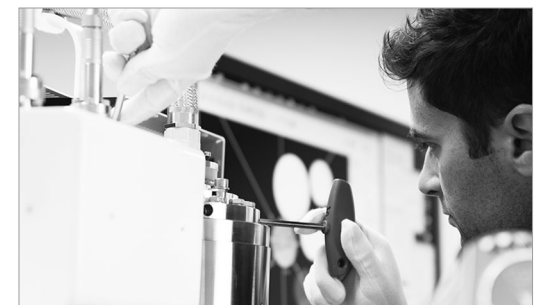

Profit from the optimized performance of your microscope system with services from ZEISS – now and for years to come.

>> www.zeiss.com/microservice



Carl Zeiss Microscopy GmbH
07745 Jena, Germany
microscopy@zeiss.com
www.zeiss.com/axiovert

**Instruments**
info@ctk-instruments.com
www.ctk-instruments.com
866-464-1005



We make it visible.